

BAU- UND MÖBELBESCHLÄGE

LAGERSORTIMENT HETTICH

» 2021



Scharniere 11 – 29

Klappenbeschläge 31 – 35

Schubkastensysteme 37 – 60

Auszugsführungen für Holzschubkästen 61 – 75

Schiebe- und Falttürsysteme 77 – 90

Verbindungstechnik 92 – 107

Schrankinnenausstattung 109 – 116

Möbelschließsysteme 117 – 125

Büromöbelsysteme 127 – 138

ProDecor Griffe 139 – 150

Verarbeitungshilfen 151 – 155

Bestellnummernverzeichnis 156 – 169



24-STUNDEN-SERVICE FÜR E/D/E LAGERARTIKEL

FAKTEN FÜR IHREN ERFOLG

- » 24-Stunden-Lieferservice
Für alle per Kurier-/Express-/Paketdienst lieferbaren Produkte beträgt die Regellieferdauer einen Tag.
Für die taggleiche Abwicklung benötigt das E/D/E die Aufträge (Montag bis Freitag) online bis 17:00 Uhr, schriftlich und telefonisch bis 15:00 Uhr.
- » Über 110.000 Artikel
- » Rund 35.000 Positionen pro Arbeitstag
- » Über 170.000 Lagerplätze
- » Über 8.000 Pakete täglich
- » Vollautomatisches Kleinteilelager
- » Lagerhaltung und Logistik des E/D/E zertifiziert nach DIN EN ISO 9001:2015

DER SCHNELLE UND GÜNSTIGE E/D/E LIEFERSERVICE

DIE VERSANDARTEN FÜR IHRE eLC BESTELLUNGEN

	Lieferrhythmus	Auftragsannahmezeiten
Speditionsversand – wöchentlich	Aufträge werden gesammelt und per Stückgut wöchentlich an Ihr Lager geliefert.	Elektronisch bis 18:00 Uhr des Vortags der Kommissionierung. Schriftlich und telefonisch bis 15:00 Uhr des Vortags der Kommissionierung.
Speditionsversand – täglich	Aufträge werden täglich per Stückgut an Ihr Lager oder Ihre Endkunden geliefert.	Elektronisch bis 12:00 Uhr – taggleiche Abwicklung. Schriftlich und telefonisch bis 11:00 Uhr – taggleiche Abwicklung
Paketversand Standard	Je Auftrag täglich per Paketdienst. Zustellung erfolgt am Folgetag (MO–FR) an Ihr Lager oder Ihre Endkunden.	Elektronisch bis 17:00 Uhr – taggleiche Abwicklung. Schriftlich und telefonisch bis 15:00 Uhr – taggleiche Abwicklung.
Paketversand Express	Je Auftrag täglich per Paketdienst. Garantierte Zustellung am Folgetag (MO–FR) an Ihr Lager oder Ihre Endkunden. Wählbare Expressvarianten: Express Saver – EOD (End of Day) Express 12:00 Uhr (nur innerhalb Deutschlands) Express 10:30 Uhr Express 09:00 Uhr	Elektronisch bis 17:00 Uhr – taggleiche Abwicklung. Schriftlich und telefonisch bis 15:00 Uhr – taggleiche Abwicklung.
Last Minute	Je Auftrag täglich per Paketdienst. Garantierte Zustellung erfolgt am Folgetag (MO–FR) an Ihr Lager oder Ihre Endkunden.	Ausschließlich telefonisch bis 21:00 Uhr – taggleiche Abwicklung (maximal zehn Artikel). Telefon: +49 202 6096-9000



DER SCHNELLE UND GÜNSTIGE E/D/E LIEFERSERVICE

DIE VERSANDARTEN FÜR IHRE eLC BESTELLUNGEN

	Versandkosten (Deutschland)	Besonderheiten
Speditionsversand – wöchentlich	3 % Frachtpauschale + Maut Keine Auslieferung unter 250,- € Gesamtauftragswert.	Sind zum Zeitpunkt der Bestellung 250,- € Mindestauftragswert nicht erreicht, werden wir Sie per E-Mail informieren*.
Speditionsversand – täglich	3,75 % Frachtpauschale + Maut	Bei dem Speditionsversand täglich erheben wir eine Mindestpauschale von 19,90 € bei Lieferungen an das Mitgliedslager oder den Endkunden. Darüber hinaus bleiben die prozentualen Regelungen bestehen. Für Rückstandslieferungen entstehen keine Zusatzkosten. Bei Rückstandsauslieferung wird automatisch die schnellste Versandart ausgewählt und berechnet: „Speditionsversand – täglich“ oder „Paketversand“.
Paketversand Standard	Paketpreise finden Sie im E/D/E Extranet unter dem Menüpunkt „Logistikzentrum“.	Sind die bestellten Artikel z. B. aufgrund der Abmessungen nicht paketdienstfähig, werden sie automatisch auf „Speditionsversand – täglich“ umgestellt und ausgeliefert. Es gelten die Versandbedingungen für Speditionsversand-täglich. Bei Rückstandsauslieferung per Paketdienst wird der Paketpreis berechnet*. Beschränkungen: Tatsächliches Gewicht bis 30 kg, Länge bis 128 cm, zweit längste Seite bis 76 cm (inkl. Verpackung).
Paketversand Express	Paketpreise finden Sie im E/D/E Extranet unter dem Menüpunkt „Logistikzentrum“.	Besonderheiten siehe Standard. Beschränkungen: Tatsächliches Gewicht bis 30 kg, Länge bis 128 cm, zweitlängste Seite bis 76 cm (inkl. Verpackung).
Last Minute	Paketpreis (Express) + 25,- € Servicegebühr je Auftrag. Exakte Paketpreise finden Sie jederzeit im E/D/E Extranet unter dem Menüpunkt „Logistikzentrum“.	Besonderheiten siehe Standard. Beschränkungen: Tatsächliches Gewicht bis 30 kg, Länge bis 128 cm, zweitlängste Seite bis 76 cm (inkl. Verpackung).
Logistikkosten-aufschlag für Kleinstlieferungen	Frachtkosten + Zuschlag von 1,79 €.	Für Aufträge ≤ 15,00 € wird ein Zuschlag von 1,79 € erhoben. Dies gilt unabhängig von der Versandart für alle Lieferungen an das Mitgliedslager oder Endkunden im In- und Ausland. Für Rückstandslieferungen entstehen keine Zusatzkosten.

*Aus logistischen Gründen können die Versandarten verändert werden.





DER SCHNELLE UND GÜNSTIGE E/D/E LIEFERSERVICE

KENNZEICHNUNGEN FÜR DEN PAKETVERSAND

Kennzeichnung	Beschreibung
<i>keine Kennzeichnung</i>	Lieferung per KEP ohne Einschränkung möglich. Fixpreis: 4,29 €
z	Lieferung per KEP gegen Aufschlag wenn keine Standardverpackung.
!	Lieferung per KEP nur eingeschränkt möglich: - kein Express - keine Lieferung nach DK, EE, FI, GB, GR, HU, IE, LT, LV, NO, RO, SE, SK, TR. - keine Insellieferung
x	Lieferung per KEP nicht möglich (Lieferung erfolgt per Speditionsversand).
z-L	Artikel inkl. Verpackung, deren längste Seite 128 cm oder die zweitlängste Seite 76 cm übersteigt Zuschlag: 5,80 €
z-XL	Artikel inkl. Verpackung, deren Gesamtabmessung 300 cm in Länge plus Umfang = (2 x Breite) + (2 x Höhe) übersteigt Zuschlag: 22,80 €
z-XXL	Artikel deren Länge über 274 cm beziehungsweise Gesamtabmessungen über 400 cm in Länge und Umfang (2 x Breite) + (2 x Höhe) überschreitet Zuschlag: 43,90 €

AUF WUNSCH LIEFERN WIR WERKSLAGER-ARTIKEL DIREKT UND KOSTENFREI ZU IHREN KUNDEN!

» **Schneller, günstiger, bequemer**

NUTZEN SIE DIE ZAHLREICHEN VORTEILE DER DIREKTBELIEFERUNG:

» **Zeitersparnis**

Der gewünschte Artikel muss von Ihnen nicht kommissioniert werden und ist schneller bei Ihren Kunden.

» **Kostensenkung**

Durch die Direktbelieferung innerhalb Deutschlands entstehen für Sie keine Versand- und Lagerkosten.

» **Bequeme Abwicklung**

Bestellung und Berechnung funktionieren wie eine herkömmliche E/D/E Lagerbestellung.

» **Mehr Sicherheit**

Durch kürzere Lieferwege wird das Risiko von Transportschäden deutlich minimiert.

Werkslager-Artikel sind in der vorliegenden Lagerliste durch den Hinweis

„**Direkte, kostenfreie Werkslieferung an Ihre Wunschadresse!**“

gekennzeichnet. Geben Sie bei der Bestellung an, wohin die gewünschte Ware geschickt werden soll.

Sollte in Einzelfällen eine Rücksendung des bestellten Artikels notwendig sein, senden Sie diese nach Rücksprache mit dem zuständigen E/D/E Fachbereich originalverpackt an den Hersteller zurück. Die anfallenden Versandkosten gehen zu Lasten des Rücksenders.

Ein E/D/E Retourenschein kann nicht ausgestellt werden. Voraussetzung ist außerdem, dass die Ware zum Rücksendezeitpunkt nicht älter als 8 Tage ist.





SIE HABEN DIE WAHL: WELCHEN ZUSÄTZLICHEN LIEFERSERVICE MÖCHTEN SIE NUTZEN?

Lieferservice	Leistung
PAKETLIEFERUNG	
Info-Mail	Der Empfänger wird unter der angegebenen E-Mail-Adresse über das Zustelldatum informiert
SPEDITIONSLIEFERUNG	
Info-Text	Dem Transportdienstleister können in einem Textfeld mit max. 30 Zeichen Zusatzinformationen (z.B. Warenannahmezeiten, Entladestelle, etc.) übermittelt werden
Fahrer-Avisierung	Der Fahrer des Transportdienstleisters teilt dem Empfänger am Tag der Zustellung telefonisch (vorzugsweise per Mobilnummer) die voraussichtliche Ankunftszeit mit
Terminabsprache	Telefon: Der Transportdienstleister vereinbart telefonisch (vorzugsweise per Mobilnummer) den Zustelltermin mit dem Empfänger
	SMS: Der Empfänger erhält zwecks Absprache des Zustelltermins eine SMS
	E-Mail: Der Empfänger erhält zwecks Absprache des Zustelltermins eine E-Mail
Express-Service* Die Zustellung erfolgt innerhalb Deutschlands, ohne Inseln und Randgebiete, am nächsten Werktag (Montag bis Freitag)	Von 6:00 bis 8:00 Uhr
	Von 6:00 bis 10:00 Uhr
	Von 6:00 bis 12:00 Uhr
	Von 8:00 bis 16:00 Uhr
	Von 18:00 bis 22:00 Uhr
1 - Mann-Zustellservice	Standard: Nach einmaliger, kostenloser Telefonabsprache (vorzugsweise Mobilnummer) erfolgt das Abtragen der Ware durch eine Person bis zur Verwendungsstelle
	Plus: Nach einmaliger, kostenloser Telefonabsprache (vorzugsweise Mobilnummer) erfolgt das Abtragen der Ware durch eine Person, inkl. Entpacken und Rücknahme der Verpackung bis zur Verwendungsstelle
2 - Mann-Zustellservice	Standard: Nach einmaliger, kostenloser Telefonabsprache (vorzugsweise Mobilnummer) erfolgt das Abtragen der Ware durch zwei Personen bis zur Verwendungsstelle
	Plus: Nach einmaliger, kostenloser Telefonabsprache (vorzugsweise Mobilnummer) erfolgt das Abtragen der Ware durch zwei Personen, inkl. Entpacken und Rücknahme der Verpackung bis zur Verwendungsstelle

*Bitte beachten Sie, dass bei Sendungen ab unserem eLC bzw. eLC II für die folgenden Postleitzahlen ein Express-Service nicht angeboten werden kann:

Bundesland	eLC - Wuppertal	eLC II - Schwebheim
Baden-Württemberg	-	78266, 78462
Bayern	83256	82380-82383, 82401, 82409, 82433-82436, 82442, 82445, 82467-82499, 87491, 87567-87569
Brandenburg	16307, 16789, 16837, 16866-16949	-
Mecklenburg-Vorpommern	18565	17000-17999, 18000-18999, 19000-19999, 23936-23999



Bemerkung	GTIN (EAN)	Preis €
E-Mail-Adresse erforderlich	4053569795159	 kostenlos
Kombinierbar mit allen Lieferservice-Angeboten	4053569794824	kostenlos
Kombinierbar mit allen Lieferservice-Angeboten	4053569794831	6,- €
Kontaktangaben entsprechend des gewählten Service erforderlich. Ohne Absprache oder Rückmeldung erfolgt keine Zustellung	4053569794817	 6,- € (D) 11,- € (EU)
	4053569795166	6,- €
	4053569795173	6,- €
Maximal Maße und Gewicht: 3 Stellplätze im Kleintransporter á Seitenlänge 1,2 m x Breite 0,8 m x Höhe 1,6 m, bis 1.000 kg	4053569795210	25,- €
Maximal Maße und Gewicht: Seitenlänge 2,4 m x Höhe 2,3 m, bis 2.000 kg	4053569795227	85,- €
	4053569795234	50,- €
	4053569795180	25,- €
	4053569795203	125,- €
Vorherige Avisierung und Klärung der Abliefersituation vor Ort durch den zustellenden Betrieb. Maximal Maße und Gewicht: Seitenlänge 2,4 m x Höhe 2,0 m, bis 30 kg	4053569795241	30,- €
	4053569795258	50,- €
Vorherige Avisierung und Klärung der Abliefersituation vor Ort durch den zustellenden Betrieb. Maximal Maße und Gewicht: B 2,4 m x H 2,0 m, bis 150 kg (mit Hubwagen) oder 30 kg (zum Abtragen pro Mann)	4053569795265	65,- €
	4053569795272	95,- €



Nutzbar auch für Lieferungen
ins europäische Ausland

Bundesland	eLC-Wuppertal	eLC II - Schwebheim
Niedersachsen	26465, 26474, 26486, 26548, 26571, 26579, 26757	21726-21737, 21762-21789, 26160-26169, 26188, 26219, 26340-26345, 26382-26909
Schleswig-Holstein	27498, 25845, 25846-25847, 25849, 25859, 25863, 25869, 25929-25933, 25938-25942, 25946-25949, 25952-25955, 25961-25970, 25980, 25985-25986, 25988-25990, 25992-25994, 25996-25999	23795-23812, 23812-23829, 24103-24539, 24582-24628, 24631, 24634-24638, 24644-24999, 25541-25563, 25572-25576, 25579-25585, 25588-25596, 25693-25999



Scharniere

► Übersicht



Sensys Scharniere

12



Sensys für Glasanwendungen

16



Montageplatten und Zubehör für Sensys

16



Intermat Scharniere und Zubehör

20



Easys für Kühlschränke

24



Öffnungssystem für grifflose Möbelfronten,
Push to open, Push to open Silent, Zubehör

24



Perfekt Scharniere

25





Selekt Scharniere und Zubehör

26







Spezialscharniere

27

	Kat-Nr	Händler/EAN	Artikelbeschreibung	ME	VPE	€/ 100*	Katalog / Seite
Sensys 8645i, Öffnungswinkel 110°, mit integrierter Dämpfung							
	9073605	4023149696497	Basis 12,5 mm, TH 52, zum Anschrauben	ST	1	302,57	T&A 26
	9073606	4023149697722	Basis 3 mm, TH 52, zum Anschrauben	ST	1	321,34	T&A 26
	9073607	4023149698798	Basis -4 mm, TH 52, zum Anschrauben	ST	1	340,12	T&A 26
	9073611	4023149696800	Basis 12,5 mm, TH 54, Schnellmontage Flash	ST	1	333,05	T&A 26
	9073612	4023149697913	Basis 3 mm, TH 54, Schnellmontage Flash	ST	1	351,83	T&A 26
	9073613	4023149698880	Basis -4 mm, TH 54, Schnellmontage Flash	ST	1	370,61	T&A 26
	9073614	4023149696992	Basis 12,5 mm, THS 55, Schnellmontage Fix	ST	1	356,33	T&A 26
	9073615	4023149698392	Basis 3 mm, THS 55, Schnellmontage Fix	ST	1	375,11	T&A 26
	9073616	4023149699382	Basis -4 mm, THS 55, Schnellmontage Fix	ST	1	393,88	T&A 26
	9091739	4023149090592	Obsidianschwarz, Basis 3 mm, TH 52, zum Anschrauben	ST	1	373,09	T&A 27
	9091740	4023149145186	Obsidianschwarz, Basis -4 mm, TH 52, zum Anschrauben	ST	1	395,62	T&A 27
	9091738	4023149651717	Obsidianschwarz, Basis 12,5 mm, TH 52, zum Anschrauben	ST	1	350,55	T&A 27
	9091772	4023149145360	Obsidianschwarz, Basis 3mm, TH 58, ø 10 x 11, mit vorm. Spreizmuffen	ST	1	400,06	T&A 27
	9091773	4023149145377	Obsidianschwarz, Basis -4 mm, TH 58, ø 10 x 11, mit vorm. Spreizmuffen	ST	1	422,57	T&A 27
	9091771	4023149091612	Obsidianschwarz, Basis 12,5 mm, TH 58, ø 10 x 11, mit vorm. Spreizmuffen	ST	1	377,52	T&A 27







	Kat-Nr	Händler/EAN	Artikelbeschreibung	ME	VPE	€ / 100*	Katalog / Seite
Sensys 8645, Öffnungswinkel 110°, ohne integrierte Dämpfung							
	9073638	4023149231599	Basis 12,5 mm, TH 52, zum Anschrauben	ST	1	219,10	T&A 26
	9073639	4023149232305	Basis 3 mm, TH 52, zum Anschrauben	ST	1	237,88	T&A 26
	9073640	4023149233968	Basis -4 mm, TH 52, zum Anschrauben	ST	1	256,64	T&A 26
	9073644	4023149240010	Basis 12,5 mm, THS 55, Schnellmontage Fix	ST	1	272,87	T&A 26
	9073645	4023149240409	Basis 3 mm, THS 55, Schnellmontage Fix	ST	1	291,65	T&A 26
	9073646	4023149241130	Basis -4 mm, THS 55, Schnellmontage Fix	ST	1	310,43	T&A 26





Sensys 8675, Öffnungswinkel 110°, ohne Schließautomatik							
	9073662	4023149256721	Basis 12,5 mm, TH 52, zum Anschrauben	ST	1	239,96	T&A 26
	9073663	4023149257025	Basis 3 mm, TH 52, zum Anschrauben	ST	1	258,74	T&A 26
	9073664	4023149257773	Basis -4 mm, TH 52, zum Anschrauben	ST	1	277,53	T&A 26
	9073668	4023149264641	Basis 12,5 mm, THS 55, Schnellmontage Fix	ST	1	293,73	T&A 26
	9073669	4023149265747	Basis 3 mm, THS 55, Schnellmontage Fix	ST	1	312,52	T&A 26
	9073670	4023149265891	Basis -4 mm, THS 55, Schnellmontage Fix	ST	1	331,30	T&A 26

	Kat-Nr	Händler/EAN	Artikelbeschreibung	ME	VPE	€/ 100*	Katalog / Seite
Sensys 8631i, Öffnungswinkel 95°, für dicke Türen mit integrierter Dämpfung							
	9091400	4023149875809	Basis 12,5 mm, TH 52, zum Anschrauben	ST	1	333,85	T&A 30
	9091410	4023149879609	Basis 3 mm, TH 52, zum Anschrauben	ST	1	352,63	T&A 30
	9091420	4023149875878	Basis -4 mm, TH 52, zum Anschrauben	ST	1	371,42	T&A 30
	9091402	4023149876103	Basis 12,5 mm, TH 54, Schnellmontage Flash	ST	1	364,36	T&A 30
	9091412	4023149113161	Basis 3 mm, TH 54, Schnellmontage Flash	ST	1	383,14	T&A 30
	9091422	4023149113987	Basis -4 mm, TH 54, Schnellmontage Flash	ST	1	401,92	T&A 30
Sensys 8661, Öffnungswinkel 95°, für dicke Türen, ohne integrierte Dämpfung							
	9091580	4023149254031	Basis 12,5 mm, TH 52, zum Anschrauben	ST	1	271,26	T&A 30
	9091590	4023149253287	Basis 3 mm, TH 52, zum Anschrauben	ST	1	290,04	T&A 30
	9091600	4023149252969	Basis -4 mm, TH 52, zum Anschrauben	ST	1	308,82	T&A 30
Sensys 8646i, Öffnungswinkel 110°, für dünne Türen, mit integrierter Dämpfung							
	9094270	4023149729539	Basis 12,5 mm, TH 52, zum Anschrauben	ST	1	417,31	T&A 34
	9094280	4023149730009	Basis 3 mm, TH 52, zum Anschrauben	ST	1	436,09	T&A 34
	9094290	4023149730337	Basis -4 mm, TH 52, zum Anschrauben	ST	1	454,87	T&A 34
Sensys 8676, Öffnungswinkel 110°, ohne Schließautomatik							
	9094450	4023149733512	Basis 12,5 mm, TH 52, zum Anschrauben	ST	1	354,72	T&A 34
	9094460	4023149734304	Basis 3 mm, TH 52, zum Anschrauben	ST	1	373,50	T&A 34
	9094470	4023149734540	Basis -4 mm, TH 52, zum Anschrauben	ST	1	392,28	T&A 34

	Kat-Nr	Händler/EAN	Artikelbeschreibung	ME	VPE	€ / 100*	Katalog / Seite
Sensys 8657i, Null-Einsprungscharnier, Öffnungswinkel 165°, mit integrierter Dämpfung							
	9099540	4023149847622	Basis 12,5 mm, TH 52, zum Anschrauben	ST	1	568,99	T&A 38
	9099550	4023149839177	Basis 3 mm, TH 52, zum Anschrauben	ST	1	585,50	T&A 38
	9099542	4023149848469	Basis 12,5 mm, TH 54, Schnellmontage Flash	ST	1	595,81	T&A 38
	9099543	4023149848087	Basis 12,5 mm, THS 55, Schnellmontage Fix	ST	1	625,46	T&A 38
	9099553	4023149839214	Basis 3 mm, THS 55, Schnellmontage Fix	ST	1	641,98	T&A 38
Sensys 8657, Null-Einsprungscharnier, Öffnungswinkel 165°, ohne integrierte Dämpfung							
	9099600	4023149849343	Basis 12,5 mm, TH 52, zum Anschrauben	ST	1	495,58	T&A 38
	9099610	4023149851223	Basis 3 mm, TH 52, zum Anschrauben	ST	1	512,10	T&A 38
	9099603	4023149849978	Basis 12,5 mm, THS 55, Schnellmontage Fix	ST	1	552,03	T&A 38
Sensys 8687, Null-Einsprungscharnier, Öffnungswinkel 165°, ohne Schließautomatik							
	9099660	4023149852848	Basis 12,5 mm, TH 52, zum Anschrauben	ST	1	513,92	T&A 38
	9099670	4023149738722	Basis 3 mm, TH 52, zum Anschrauben	ST	1	530,44	T&A 38
Sensys 8639i W30, Öffnungswinkel 95°, mit integrierter Dämpfung							
	9088016	4023149390654	Basis 2 mm, TH 52, zum Anschrauben	ST	1	593,64	T&A 42
	9088017	4023149391507	Basis -16 mm, TH 52, zum Anschrauben	ST	1	588,03	T&A 42
Sensys 8639i W45, Öffnungswinkel 95°, mit integrierter Dämpfung							
	9088018	4023149388927	Basis 9 mm, TH 52, zum Anschrauben	ST	1	593,64	T&A 46
	9088019	4023149344374	Basis -2 mm, TH 52, zum Anschrauben	ST	1	593,64	T&A 46
	9088020	4023149391545	Basis -25 mm, TH 52, zum Anschrauben	ST	1	588,03	T&A 46

Unverbindliche Preisempfehlung. Preise gültig bei Abnahme von ganzen Verpackungseinheiten zzgl. MwSt.

	Kat-Nr	Händler/EAN	Artikelbeschreibung	ME	VPE	€/ 100*	Katalog / Seite
Sensys 8639i W90, Öffnungswinkel 95°, mit integrierter Dämpfung							
	9088021	4023149346279	Basis 4 mm, TH 52, zum Anschrauben	ST	1	593,64	T&A 50
	9088075	4023149258954	Basis 4 mm, THS 55, Schnellmontage Fix	ST	1	654,52	T&A 50
Intermat 9930, Öffnungswinkel 50 / 65°, mit Topf im Sensys Design für Eckschrankfalttüren							
	9090109	4023149229039	Basis 24 mm, TH 52, zum Anschrauben	ST	1	501,00	T&A 58
Sensys für Glasanwendungen							
	9135141	4023149163296	Sensys 8645i für Glasanwendungen, Öffnungswinkel 110°	ST	1	1.034,00	T&A 80
	9135140	4023149163333	Sensys 8657i für Glasanwendungen, Öffnungswinkel 165°	ST	1	909,54	T&A 80
	9116092	4023149163319	Gehäuse zur Klebmontage	ST	1	517,02	T&A 80
	9133534	4023149163357	Montageplatte zur Klebmontage, D = 10,0 mm	ST	1	1.407,44	T&A 81
	9133536	4023149163371	Montageplatte zur Klebmontage, D = 10,0 mm	ST	1	1.407,44	T&A 81
	9081923	4023149871269	Adapter zur Klebmontage für Sensys, für TH 52, voll vorliegend, Glasdicke 3 - 7 mm	ST	1	543,02	T&A 81
							
				Weitere Informationen finden Sie hier: hettich.com/short/59c98b			
Kreuzmontageplatte zum Anschrauben, für Sensys, mit Langloch-Höhenverstellung							
	9075005	4023149385766	D = 0,0 mm	ST	1	33,65	T&A 62
	9075006	4023149385803	D = 1,5 mm	ST	1	33,65	T&A 62
Kreuzmontageplatte mit vormontierten Euroschrauben, für Sensys, mit Langloch-Höhenverstellung							
	9075055	4023149113970	D = 0,0 mm, ø 5 x 12 mm	ST	1	35,25	T&A 62
	9075056	4023149118142	D = 1,5 mm, ø 5 x 12 mm	ST	1	35,25	T&A 62
	9075057	4023149118319	D = 3,0 mm, ø 5 x 12 mm	ST	1	41,66	T&A 62
	9075058	4023149125935	D = 5,0 mm, ø 5 x 12 mm	ST	1	56,08	T&A 62

	Kat-Nr	Händler/EAN	Artikelbeschreibung	ME	VPE	€/ 100*	Katalog / Seite
Linear-Montageplatte mit Direkt-Höhenverstellung, vernickelt, zum Anschrauben							
	9117341	4023149194658	D = 1,5 mm, ø 20 x 32 mm	ST	1	107,34	T&A 64
Kreuzmontageplatte mit Spreizmuffen und Spezialschrauben, für Sensys, mit Exzenter-Höhenverstellung							
	9075070	4023149127410	D = 0,0 mm, ø 5 x 12 mm	ST	1	67,28	T&A 63
	9075071	4023149127441	D = 1,5 mm, ø 5 x 12 mm	ST	1	67,28	T&A 63
	9075072	4023149127519	D = 3,0 mm, ø 5 x 12 mm	ST	1	73,69	T&A 63
	9075073	4023149127618	D = 5,0 mm, ø 5 x 12 mm	ST	1	88,11	T&A 63
Kreuzmontageplatte mit vormontierten Spanplattenschrauben, für Sensys, mit Exzenter-Höhenverstellung							
	9075085	4023149151729	D = 0,0 mm, ø 2,5 mm	ST	1	67,28	T&A 63
	9075086	4023149151897	D = 1,5 mm, ø 2,5 mm	ST	1	67,28	T&A 63
	9075087	4023149151965	D = 3,0 mm, ø 2,5 mm	ST	1	73,69	T&A 63
	9075088	4023149152566	D = 5,0 mm, ø 2,5 mm	ST	1	88,11	T&A 63
Kreuzmontageplatte mit vormontierten Euroschrauben, für Sensys, mit Exzenter-Höhenverstellung							
	9075080	4023149148392	D = 0,0 mm, ø 5 x 12 mm	ST	1	66,48	T&A 63
	9075081	4023149149023	D = 1,5 mm, ø 5 x 12 mm	ST	1	66,48	T&A 63
	9075082	4023149151248	D = 3,0 mm, ø 5 x 12 mm	ST	1	72,89	T&A 63
	9075083	4023149151286	D = 5,0 mm, ø 5 x 12 mm	ST	1	87,31	T&A 63
	9075060	4023149125973	D = 0,0 mm, ø 5 x 8 mm	ST	1	67,28	T&A 64
	9075061	4023149126369	D = 1,5 mm, ø 5 x 8 mm	ST	1	67,28	T&A 64
	9075062	4023149126475	D = 3,0 mm, ø 5 x 8 mm	ST	1	73,69	T&A 64
	9075063	4023149126499	D = 5,0 mm, ø 5 x 8 mm	ST	1	88,11	T&A 64

Unverbindliche Preisempfehlung. Preise gültig bei Abnahme von ganzen Verpackungseinheiten zzgl. MwSt.

	Kat-Nr	Händler/EAN	Artikelbeschreibung	ME	VPE	€/ 100*	Katalog / Seite
	9091803	4023149651724	D = 0,0 mm, ø 5 x 12 mm obsidianschwarz	ST	1	77,86	T&A 67
	9091804	4023149145674	D = 1,5 mm, ø 5 x 12 mm obsidianschwarz	ST	1	77,86	T&A 67
	9091805	4023149097973	D = 3,0 mm, ø 5 x 12 mm obsidianschwarz	ST	1	85,55	T&A 67
	9091806	4023149145681	D = 5,0 mm, ø 5 x 12 mm obsidianschwarz	ST	1	102,85	T&A 67

Patenterte Kreuzmontageplatte Hettich Direkt mit Pilotzapfen und Spezialschrauben, mit Exzenter-Höhenverstellung



9075065	4023149126581	D = 0,0 mm, ø 5 x 7,5 mm	ST	1	67,28	T&A 64
9075066	4023149126604	D = 1,5 mm, ø 5 x 7,5 mm	ST	1	67,28	T&A 64
9075067	4023149126666	D = 3,0 mm, ø 5 x 7,5 mm	ST	1	73,69	T&A 64
9075068	4023149126987	D = 5,0 mm, ø 5 x 7,5 mm	ST	1	88,11	T&A 64

Paralleladapter für Kreuzmontageplatte, für Sensys



9072537	4023149176609	D = 8,0 mm	ST	1	123,19	T&A 68
---------	---------------	------------	----	---	--------	--------

Adapterplatte









9106986	4023149159879	zur Anbindung an Paralleladapter, D = 0,0 mm, mit vorm. Euroschrauben	ST	1	132,02	T&A 68
9106987	4023149159886	zur Anbindung an Paralleladapter, D = 1,5 mm, mit vorm. Euroschrauben	ST	1	132,02	T&A 68
9106988	4023149159893	zur Anbindung an Paralleladapter, D = 3,0 mm, mit vorm. Euroschrauben	ST	1	138,41	T&A 68

Winkeladapter für Kreuzmontageplatten, für Sensys



9072533	4023149161025	5°, Lochreihe 37 mm	ST	1	94,19	T&A 69
9072534	4023149162022	10°, Lochreihe 37 mm	ST	1	101,45	T&A 69
9072535	4023149162480	15°, Lochreihe 37 mm	ST	1	108,69	T&A 69
9072536	4023149170140	20°, Lochreihe 37 mm	ST	1	123,19	T&A 69

	Kat-Nr	Händler/EAN	Artikelbeschreibung	ME	VPE	€/ 100*	Katalog / Seite
Abdeckkappe für Sensys Scharnierarm							
	9088250	4023149182464	geprägt mit Hettich Logo	ST	1	12,49	T&A 69
	9088249	4023149181269	neutral	ST	1	12,49	T&A 69
	9091821	4023149089725	geprägt mit Hettich Logo obsidianschwarz	ST	1	14,97	T&A 69
	9091820	4023149096495	neutral obsidianschwarz	ST	1	14,97	T&A 69
Abdeckkappe für Sensys Null-Einsprungscharnier							
	9099870	4023149980855	neutral	ST	1	28,70	T&A 70
	9099871	4023149982125	bedruckt mit Hettich Logo	ST	1	28,70	T&A 70
Abdeckkappe für Sensys Scharniertopf							
	9088251	4023149184512	für TH / TS	ST	1	16,06	T&A 70
	9091822	4023149089220	für TH / TS obsidianschwarz	ST	1	19,28	T&A 70
Öffnungsdämpfung für Sensys Null-Einsprungscharnier							
	9100037	4023149982521	voll vorliegend	ST	1	34,30	T&A 70
	9100116	4023149854194	halb vorliegend	ST	1	34,30	T&A 70
Öffnungswinkelbegrenzer für Sensys 8645i und 8639i							
	9072540	4023149191312	für Sensys 8645i, Begrenzung von 110° auf 85°	ST	1	11,34	T&A 71
	9072541	4023149194580	für Sensys 8639i W, Begrenzung von 95° auf 85°	ST	1	11,34	T&A 72
Montagehilfe							
	9081657	4023149438059	für Öffnungswinkelbegrenzer für Sensys	ST	1	358,75	T&A 72
Öffnungswinkelbegrenzer für Sensys 8657i, Null-Einsprungscharnier							
	9090756	4023149840517	Begrenzung von 165° auf 105° oder 120°	ST	1	14,35	T&A 71
	9090864	4023149968419	Begrenzung von 165° auf 90° oder 135°	ST	1	14,35	T&A 72









Unverbindliche Preisempfehlung. Preise gültig bei Abnahme von ganzen Verpackungseinheiten zzgl. MwSt.

	Kat-Nr	Händler/EAN	Artikelbeschreibung	ME	VPE	€/ 100*	Katalog / Seite
Schraube und Muffe für Scharniere mit Topfmontage zum Einpressen							
	0045169	4023149451690	ø 10 x 11 mm	GN	1	10,40	T&A 73



Befestigungsschraube für Scharniertopf zum Anschrauben							
	0071925	4023149719257	Senkkopf, ø 3,5 x 16 mm	ST	1	4,45	T&A 73

Intermat 9943, Öffnungswinkel 110°							
	0048049	4023149068058	Basis 12,5 mm, TH 42, zum Anschrauben	ST	1	136,63	.
	0048051	4023149480515	Basis 3 mm, TH 42, zum Anschrauben	ST	1	153,55	.
	0048052	4023149084287	Basis -3,5 mm, TH 42, zum Anschrauben	ST	1	157,46	.
	0048053	4023149067501	Basis 12,5 mm, TH 43, zum Einpressen	ST	1	153,41	.
	0048054	4023149084294	Basis 3 mm, TH 43, zum Einpressen	ST	1	170,34	.
	0048055	4023149073571	Basis -3,5 mm, TH 43, zum Einpressen	ST	1	174,26	.
	0048059	4023149069369	Basis 12,5 mm, TH 44, Schnellmontage Flash	ST	1	166,02	.
	0048061	4023149084300	Basis 3 mm, TH 44, Schnellmontage Flash	ST	1	182,93	.
	0048062	4023149065873	Basis -3,5 mm, TH 44, Schnellmontage Flash	ST	1	186,84	.

Intermat 9935, Öffnungswinkel 95° für dicke Türen bis 43 mm							
	0073925	4023149739255	Basis 18 mm, TH 22 / L, zum Anschrauben	ST	1	527,01	T&A 186
	0073926	4023149739262	Basis 8 mm, TH 22 / L, zum Anschrauben	ST	1	547,85	T&A 186
	0073927	4023149739279	Basis -3 mm, TH 22 / L, zum Anschrauben	ST	1	543,93	T&A 186

	Kat-Nr	Händler/EAN	Artikelbeschreibung	ME	VPE	€/ 100*	Katalog / Seite
Intermat 9924, für Holzrahmentüren, Öffnungswinkel 95°							
	0072959	4023149087387	Basis 11 mm, TH 42 / S, zum Anschrauben	ST	1	266,77	T&A 190
	0072965	4023149729652	Basis 2,5 mm, TH 42 / S, zum Anschrauben	ST	1	283,67	T&A 190
	0072966	4023149074684	Basis -4 mm, TH 42 / S, zum Anschrauben	ST	1	287,58	T&A 190
Intermat 9904, für Glastüren, Öffnungswinkel 95°							
	0072960	4023149029134	Basis 11 mm, TU 12 / S, zum Anschrauben	ST	1	266,77	T&A 192
	0072968	4023149081002	Basis -4 mm, TU 12 / S, zum Anschrauben	ST	1	287,58	T&A 192
Zierkappen Typ A und B, für Intermat 9904							
	0040341	4023149403415	Typ A, verchromt, hochglanz	ST	1	173,20	T&A 135
	0070712	4023149707124	Typ A, vernickelt, matt	ST	1	163,57	T&A 135
	0040495	4023149404955	Typ B, verchromt, hochglanz	ST	1	211,68	T&A 135
	0070713	4023149707131	Typ B, vernickelt, matt	ST	1	202,07	T&A 135
Abdeckkappe, Ø 35 mm							
	0025204	4023149252044	Für Bohrung ø 35 x 9,5 mm, weiß	ST	1	19,50	T&A 74
Anschlagdämpfer zum Eindrücken							
	0025048	4023149250484	Für Bohrung ø 6 x 7 mm, weiß	ST	1	9,66	T&A 74
Anschlagdämpfer zum Aufkleben							
	0046695	4023149466953	Selbstklebend, Kunststoff transparent	ST	1	6,54	T&A 74
	0072120	4023149721205	Selbstklebend, Kunststoff transparent	ST	1	7,14	T&A 74
Anschlagdämpfer zum Eindrücken							
	9079298	4023149244094	Für Bohrung ø 5 x 5,5 mm	ST	1	10,21	T&A 74

	Kat-Nr	Händler/EAN	Artikelbeschreibung	ME	VPE	€/ 100*	Katalog / Seite
Aufklipsdämpfer Silent System, für Intermat							
	0060576	4023149605765	voll vorliegend, Zinkdruckguss vernickelt	ST	1	347,37	.

Anschraubdämpfer Silent System, für Intermat							
 	0060579	4023149605796	voll vorliegend, vorliegend, halb vorliegend, zum Anschrauben, Zinkdruckguss vernickelt	ST	1	408,01	.

Scharniere

- ▶ Easys für Kühlschränke
- ▶ Öffnungssystem für grifflose Möbelfronten Push to open

	Kat-Nr	Händler/EAN	Artikelbeschreibung	ME	VPE	€ / 100*	Katalog / Seite
--	--------	-------------	---------------------	----	-----	----------	-----------------

Easys für Kühlschränke



9210848	4023149070976	inkl. Netzkabel Typ C: Europa Variante	ST	1	34.711,26	T&A 129
----------------	---------------	--	----	---	-----------	---------

Push to open Silent



9239099	4023149170324	zum Anschrauben, grau	ST	1	2.073,75	T&A 107
----------------	---------------	-----------------------	----	---	----------	---------

9239087	4023149170317	zum Anschrauben, anthrazit	ST	1	2.073,75	T&A 107
----------------	---------------	----------------------------	----	---	----------	---------

9239088	4023149170331	zum Anschrauben, weiß	ST	1	2.073,75	T&A 107
----------------	---------------	-----------------------	----	---	----------	---------

Weitere Informationen finden Sie hier:
hettich.com/short/6a155f



Push to open Pin, zum Anschrauben



9089626	4023149330407	Langhub, anthrazit	ST	1	334,91	T&A 114
----------------	---------------	--------------------	----	---	--------	---------

9089601	4023149750045	Langhub, lichtgrau	ST	1	334,91	T&A 114
----------------	---------------	--------------------	----	---	--------	---------

9089587	4023149751509	Langhub, weiß	ST	1	334,91	T&A 114
----------------	---------------	---------------	----	---	--------	---------

Push to open Pin, zum Einbohren



9089628	4023149332012	Langhub, anthrazit	ST	1	301,05	T&A 115
----------------	---------------	--------------------	----	---	--------	---------

9089603	4023149752582	Langhub, lichtgrau	ST	1	301,05	T&A 115
----------------	---------------	--------------------	----	---	--------	---------

9089589	4023149752711	Langhub, weiß	ST	1	301,05	T&A 115
----------------	---------------	---------------	----	---	--------	---------

Push to open Pin Strong, zum Anschrauben



9089636	4023149340024	Langhub, anthrazit	ST	1	343,51	T&A 116
----------------	---------------	--------------------	----	---	--------	---------







9089611	4023149753640	Langhub, lichtgrau	ST	1	343,51	T&A 116
----------------	---------------	--------------------	----	---	--------	---------

9089597	4023149754098	Langhub, weiß	ST	1	343,51	T&A 116
----------------	---------------	---------------	----	---	--------	---------





Scharniere

► Öffnungssystem für grifflose Möbelfronten Push to open, Zubehör

► Perfekt









	Kat-Nr	Händler/EAN	Artikelbeschreibung	ME	VPE	€ / 100*	Katalog / Seite
Push to open Pin Strong, zum Einbohren							
	9089638	4023149389887	Langhub, anthrazit	ST	1	308,76	T&A 117
	9089613	4023149754302	Langhub, lichtgrau	ST	1	308,76	T&A 117
	9089599	4023149957482	Langhub, weiß	ST	1	308,76	T&A 117
Push to open Magnet, zum Anschrauben							
	9089630	4023149332548	Langhub, anthrazit	ST	1	401,94	T&A 118
	9089605	4023149957536	Langhub, lichtgrau	ST	1	401,94	T&A 118
	9089591	4023149758003	Langhub, weiß	ST	1	401,94	T&A 118
Push to open Magnet, zum Einbohren							
	9089632	4023149336010	Langhub, anthrazit	ST	1	367,21	T&A 119
	9089607	4023149758263	Langhub, lichtgrau	ST	1	367,21	T&A 119
	9089593	4023149759703	Langhub, weiß	ST	1	367,21	T&A 119
Designadapter							
	9089633	4023149336997	vernickelt	ST	1	124,25	T&A 121
Push to open Universal							
	9 051 925	4023149022951	grau	ST	1	369,29	.
Perfekt 5737 W90, Öffnungswinkel 95°							
	0069603	4023149696039	TH 42, zum Anschrauben	ST	1	747,75	T&A 134
Perfekt 5224 W90, Öffnungswinkel 95°							
	0069609	4023149696091	TH 42 / S, zum Anschrauben	ST	1	669,71	T&A 134

Unverbindliche Preisempfehlung. Preise gültig bei Abnahme von ganzen Verpackungseinheiten zzgl. MwSt.







	Kat-Nr	Händler/EAN	Artikelbeschreibung	ME	VPE	€/ 100*	Katalog / Seite
Seleкта Pro 2000, Grundscharnier mit Spreizmuffen, mit Zuhaltung							
	0045066	4023149407826	Auflage 5,5 mm, Türdicke 19 mm	ST	1	577,46	T&A 140
	0045048	4023149407697	Auflage 6,5 mm, Türdicke 19 mm	ST	1	577,46	T&A 140
Seleкта Pro 2000 Zwillingsscharnier, mit Spreizmuffen mit Zuhaltung							
	0045067	4023149407833	Auflage 5,5 mm, Türdicke 19 mm	ST	1	977,32	T&A 146
	0045063	4023149407796	Auflage 6,5 mm, Türdicke 19 mm	ST	1	977,32	T&A 146
Seleкта Pro 2000, Grundscharnier mit Spreizmuffen mit Zuhaltung							
	0045065	4023149407819	Auflage 11 mm, Türdicke 19 mm	ST	1	506,91	T&A 140
	0045046	4023149407673	Auflage 12 mm, Türdicke 16 mm	ST	1	553,96	T&A 140
	0045047	4023149407680	Auflage 12 mm, Türdicke 19 mm	ST	1	506,91	T&A 142
	0045044	4023149600050	Auflage 15 mm, Türdicke 19 mm	ST	1	506,91	T&A 142
	0045045	4023149407666	Auflage 16 mm, Türdicke 19 mm	ST	1	506,91	T&A 142
Seleкта Pro 2000 E, Grundscharnier mit Spreizmuffen, mit Zuhaltung							
	0045064	4023149407802	Fuge 3,2 mm	ST	1	648,03	T&A 148
Seleкта Topf, Pro 2000							
	0077734	4023149601668	TH 32, zum Anschrauben, Bohrbild 52 x 5,5 mm	ST	1	119,24	T&A 140
	0077735	4023149601675	TH 33, zum Einpressen, Bohrbild 52 x 5,5 mm	ST	1	132,22	T&A 140
	0077736	4023149601682	TX 32, zum Anschrauben, Bohrbild 52 x 9 mm	ST	1	119,24	T&A 140
	0077887	4023149601699	TX 33, zum Einpressen, Bohrbild 52 x 9 mm	ST	1	132,22	T&A 140
	0010074	4023149600890	TB 32, zum Anschrauben, Bohrbild 45 x 9,5 mm	ST	1	111,66	T&A 140
	0077942	4023149602641	TB 33, zum Einpressen, Bohrbild 45 x 9,5 mm	ST	1	136,75	T&A 140

Scharniere

- ▶ Selekt
- ▶ Spezialscharniere

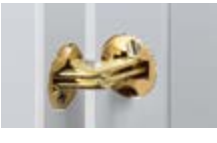



	Kat-Nr	Händler/EAN	Artikelbeschreibung	ME	VPE	€ / 100*	Katalog / Seite
Abdeckkappe für Selekt Scharnierarm							
	0010067	4023149100673	Für Selekt Pro 2000, grau	ST	1	8,89	T&A 152
Glastürscharnier ET 5150, mit Zuhaltung							
	0024908	4023149517204	Für einliegende Türen bis 1000 mm Höhe	GN	1	1.370,37	T&A 160
Glastürscharnier ET 5150 Z, mit Zuhaltung							
	0069934	4023149517198	Für einliegende Türen größer 1000 mm Höhe	ST	1	1.130,37	T&A 160
Glastürscharnier ET 5160, mit Zuhaltung							
	0030866	4023149516900	Für vorliegende Türen	GN	1	1.359,46	T&A 161
Glastürgriff							
	0025314	4023199034652	Für ET 5150, 5150Z, 5160	ST	1	580,28	T&A 160
Druckmagnetschnäpper							
	0020873	4023149208737	Druckmagnetschnäpper D 7/GP 9 11 N	ST	1	176,35	T&A 720
Mittelscharnier, Öffnungswinkel 180°, für Falttüren							
	0046787	4023149467875	mit einstellbarem, versetztem Drehpunkt, zum Anschrauben	ST	1	1.279,10	T&A 163
Mittelscharnier 625, Öffnungswinkel 180°, für Falttüren							
	0071648	4023149716485	Mittelscharnier 625	ST	1	374,42	T&A 165
Spezialscharnier Kamat							
	9239784	4023149152955	Für Kühlschrankbauten, Öffnungswinkel 115°	ST	1	2.747,72	T&A 166
	9248766	4023149170348	Abdeckkappe Kamat fenstergrau	ST	1	215,40	T&A 166

Unverbindliche Preisempfehlung. Preise gültig bei Abnahme von ganzen Verpackungseinheiten zzgl. MwSt. – Stand 02/2021

	Kat-Nr	Händler/EAN	Artikelbeschreibung	ME	VPE	€ / 100*	Katalog / Seite
Spezialscharnier ET 582, Öffnungswinkel 95°							
	0072134	4023149721342	Für Kühlschrankumbauten	ST	1	839,31	T&A 170
Schleppbeschlag							
	9079390	4023149008160	Schleppbeschlag für Kühlschrankumbauten	ST	1	2.337,51	T&A 171
Spezialscharnier Optimat Plus 4 FM, Öffnungswinkel 110°							
	9072548	4023149968310	Für Frontrahmen	ST	1	540,83	T&A 173
Einbohr-Zylinderscharnier Excellent, Öffnungswinkel 110°, zum Einbohren							
	0031168	4023149311680	ø 10 mm	ST	1	302,80	T&A 174
	0031169	4023149311697	ø 12 mm	ST	1	342,37	T&A 174
	0031170	4023149311703	ø 14 mm	ST	1	526,26	T&A 174
Einfrässcharnier, Öffnungswinkel 180°							
	9133178	4023149392658	Türdicke 18 - 25 mm	ST	1	815,91	T&A 175
	9133179	4023149392665	Türdicke 22 - 30 mm	ST	1	906,39	T&A 175
	9133191	4023149392672	Türdicke 28 - 40 mm	ST	1	2.126,84	T&A 175
Scharnier Stabilo 72, Öffnungswinkel 180°, zum Einfräsen							
	0044797	4023149447976	Ganzmetall vernickelt	ST	1	1.741,09	T&A 176
Scharnier Stabilo 75, Öffnungswinkel 180°, zum Einfräsen							
	0042339	4023149423390	Messing vernickelt / Kunststoff weiß	ST	1	1.126,59	T&A 177

Scharniere

► Spezialscharniere

	Kat-Nr	Händler/EAN	Artikelbeschreibung	ME	VPE	€ / 100*	Katalog / Seite
Aufschraubcharnier, Öffnungswinkel 90°							
	0019639	4023149196393	Für vorliegende und einliegende Türen	ST	1	287,01	T&A 178
Aufschraubcharnier mit Feder, Öffnungswinkel 165-130°							
	0020046	4023149200465	Für vorliegende und einliegende Türen	ST	1	748,65	T&A 179
Zapfenband, Öffnungswinkel 110°							
	0069933	4023149699337	Für einliegende Türen, Tückerdicke 16 - 20 mm	ST	1	339,40	T&A 181
Klappenscharnier Markant 7.1							
	0046849	4023149152917	Für vorliegende Klappen, vernickelt	GN	1	1.623,08	T&A 183
	* Montageplatten sind separat zu bestellen						
Klappenscharnier Markant 11							
	0040242	4023149507144	Für vorliegende Klappen, vernickelt	ST	1	625,88	T&A 184

Unverbindliche Preisempfehlung. Preise gültig bei Abnahme von ganzen Verpackungseinheiten zzgl. MwSt.

Klappenbeschläge

► Übersicht



Hochfalt-Beschlag Lift Advanced HF und Zubehör

32



Hochklapp-Beschlag Lift Advanced HK und Zubehör

32



Hochlift-Beschlag Lift Advanced HL und Zubehör

32



Hochschwenk-Beschlag Lift Advanced HS und Zubehör

33



Einschwenk-Beschlag Lift Up Hockklappbeschläge Lift

33



Klappenstützen Lift Basic

34



Klappenhalter Lift Mini und Zubehör, Klassik D und KH

35

Klappenbeschläge

► Lift Advanced HF, HK, HL

► Zubehör

	Kat-Nr	Händler/EAN	Artikelbeschreibung	ME	VPE	€/ 100*	Katalog / Seite
--	--------	-------------	---------------------	----	-----	---------	-----------------

Lift Advanced HF, mit Silent System



9079607	4023149008924	Lift Advanced HF, lichte Korpushöhe 551 - 610 mm	ST	1	12.597,58	T&A 204
9079610	4023149008931	Lift Advanced HF, lichte Korpushöhe 611 - 700 mm	ST	1	12.597,58	T&A 204

Gasdruckfeder zur Anpassung an individuelle Klappengewichte



9079624	4023149009006	Federkraft 300 N	ST	1	3.277,71	T&A 204
9079626	4023149641879	Federkraft 350 N	ST	1	3.277,71	T&A 204
9079628	4023149009020	Federkraft 400 N	ST	1	3.277,71	T&A 204

Lift Advanced HK, mit Silent System



9079603	4023149008900	Lift Advanced HK, lichte Korpushöhe 276 - 720 mm	ST	1	9.613,92	T&A 206
----------------	---------------	--	----	---	----------	---------

Gasdruckfeder zur Anpassung an individuelle Klappengewichte



9079618	4023149008979	Federkraft 150 N	ST	1	3.277,71	T&A 206
9079619	4023149008986	Federkraft 200 N	ST	1	3.277,71	T&A 206
9079622	4023149008993	Federkraft 250 N	ST	1	3.277,71	T&A 206
9079624	4023149009006	Federkraft 300 N	ST	1	3.277,71	T&A 204
9079626	4023149641879	Federkraft 350 N	ST	1	3.277,71	T&A 204
9079628	4023149009020	Federkraft 400 N	ST	1	3.277,71	T&A 204

Lift Advanced HL, mit Silent System



9079600	4023149008887	Lift Advanced HL, lichte Korpushöhe 403 - 462 mm	ST	1	12.597,58	T&A 208
----------------	---------------	--	----	---	-----------	---------

Ablängbare Quertraverse für Lift Advanced



9079653	4023149009129	Korpusbreite 600 mm	ST	1	1.513,42	T&A 209
9079658	4023149009143	Korpusbreite 1200 mm	ST	1	2.502,22	T&A 209

Klappenbeschläge

- ▶ Lift Advanced HS, Zubehör
- ▶ Einschwenk-Beschlag, Hochklappbeschläge

	Kat-Nr	Händler/EAN	Artikelbeschreibung	ME	VPE	€ / 100*	Katalog / Seite
Gasdruckfeder zur Anpassung an individuelle Klappengewichte							
	9079624	4023149009006	Federkraft 300 N	ST	1	3.277,71	T&A 204
	9079626	4023149641879	Federkraft 350 N	ST	1	3.277,71	T&A 204
	9079628	4023149009020	Federkraft 400 N	ST	1	3.277,71	T&A 204

Lift Advanced HS, mit Silent System							
	9079617	4023149008962	Lift Advanced HS, lichte Korpushöhe 372 - 688 mm	ST	1	12.597,58	T&A 210

Ablängbare Quertraverse für Lift Advanced							
	9079653	4023149009129	Korpusbreite 600 mm	ST	1	1.513,42	T&A 209
	9079658	4023149009143	Korpusbreite 1200 mm	ST	1	2.502,22	T&A 209

Gasdruckfeder zur Anpassung an individuelle Klappengewichte							
	9079619	4023149008986	Federkraft 200 N	ST	1	3.277,71	T&A 206
	9079622	4023149008993	Federkraft 250 N	ST	1	3.277,71	T&A 206
	9079624	4023149009006	Federkraft 300 N	ST	1	3.277,71	T&A 204
	9079626	4023149641879	Federkraft 350 N	ST	1	3.277,71	T&A 204
	9079628	4023149009020	Federkraft 400 N	ST	1	3.277,71	T&A 204

Einschwenk-Beschlag Lift Up							
	0045026	4023149450266	Für Klappendicke 18 / 19 mm, Klappengewicht bis zu 8 kg	ST	1	1.380,97	T&A 215

Hochklappbeschlag Lift Junior, Öffnungswinkel 75°							
	0079397	4023149793974	Federkraft 90 N, 2 kg	GN	1	958,35	T&A 216
	0040722	4023149407222	Federkraft 140 N, 2,5 kg	GN	1	973,00	T&A 216

Unverbindliche Preisempfehlung. Preise gültig bei Abnahme von ganzen Verpackungseinheiten zzgl. MwSt.







Klappenbeschläge

► Hochklappbeschläge, Klappenstützen

	Kat-Nr	Händler/EAN	Artikelbeschreibung	ME	VPE	€/ 100*	Katalog / Seite
Hochklappbeschlag Lift							
	0040721	4023149407215	Federkraft 80 - 220 N, 4,6 kg, Öffnungswinkel 75°	GN	1	1.702,16	T&A 217
	0010921	4023149109218	Federkraft 80 - 220 N, 4,6 kg, Öffnungswinkel 90°	GN	1	1.727,19	T&A 217
	0079389	4023149793899	Federkraft 180 N, 3,3 kg, Öffnungswinkel 90°	GN	1	1.473,58	T&A 217
Klappenstütze Lift Basic							
	9079593	4023149008832	Klappengewicht inkl. Griff bis zu 3,2 kg	ST	1	1.175,25	T&A 219

Klappenbeschläge

- ▶ Klappenhalter
- ▶ Zubehör

	Kat-Nr	Händler/EAN	Artikelbeschreibung	ME	VPE	€ / 100*	Katalog / Seite
Klappenhalter mit Seilzug LiftMini, mit Öffnungs- und Schließdämpfung							
	9206675	4023149888045	Federkraft 40 N	ST	1	4.160,67	T&A 220
	9206677	4023149887987	Federkraft 60 N	ST	1	4.160,67	T&A 220
	9206688	4023149887710	Federkraft 100 N	ST	1	4.160,67	T&A 220
	9206689	4023149887659	Federkraft 140 N	ST	1	4.160,67	T&A 220
	9206690	4023149887550	Federkraft 160 N	ST	1	4.160,67	T&A 220
	9206691	4023149887369	Federkraft 200 N	ST	1	4.160,67	T&A 220
Abdeckkappen LiftMini							
	9206692	4023149887277	weiß	ST	1	201,32	T&A 220
	9206697	4023149886881	vernickelt matt	ST	1	977,86	T&A 220
Klappenhalter Klassik D, mit Magnetzuhaltung							
	0021575	4023149215759	290 links, lichte Korpushöhe 290 - 340 mm	ST	1	1.342,80	T&A 224
	0021698	4023149216985	290 rechts, lichte Korpushöhe 290 - 340 mm	ST	1	1.342,80	T&A 224
Klappenhalter Klassik D, mit Lager LS 3280							
	0020864	4023149208645	290, lichte Korpushöhe 290-340 mm	ST	1	1.303,18	T&A 225
Klappenhalter Klassik D, mit Lager L 258 D							
	0016173	4023149044526	Lichte Korpushöhe 300 - 349 mm	ST	1	1.077,63	T&A 226
	0016174	4023149161742	Lichte Korpushöhe 350 - 399 mm	ST	1	1.100,21	T&A 226
	0016175	4023149161759	Lichte Korpushöhe 400 - 449 mm	ST	1	1.120,56	T&A 226
Klappenhalter KH							
	0013233	4023149132339	Länge 200 mm	ST	1	145,99	T&A 227
	0013235	4023149132353	Länge 250 mm	ST	1	159,18	T&A 227

Schubkastensysteme

► Übersicht



AvanTech YOU Sets
Höhen 77, 101, 139, 187, und 251 mm
Zubehör

38



Auszugsführungen Actro YOU mit Silent System und Öffnungssystem Push to open Silent

41



**AvanTech YOU
Innenorganisation**

43

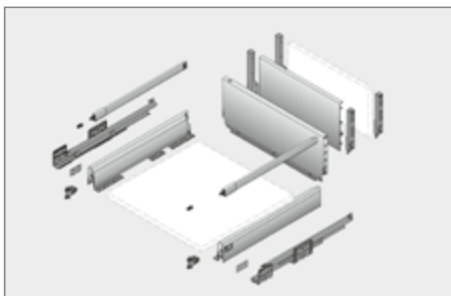

ArciTech flexible Sets, silber
Höhen 94, 126, 186 und 218 mm,
Zubehör

48



ArciTech Innenorganisation für Schubkästen und Innenschubkästen, silber

52

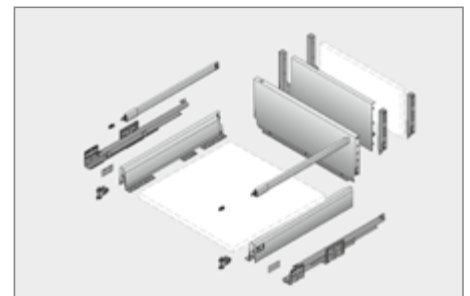

ArciTech flexible Sets, weiß
Höhen 94, 126, 186 und 218 mm
Zubehör

53



ArciTech Innenorganisation für Schubkästen und Innenschubkästen, weiß

57



Actro mit Silent System Auszugsführungen und Öffnungssystem Push to open Silent für Korpusseitendicke 18 / 19 mm

58

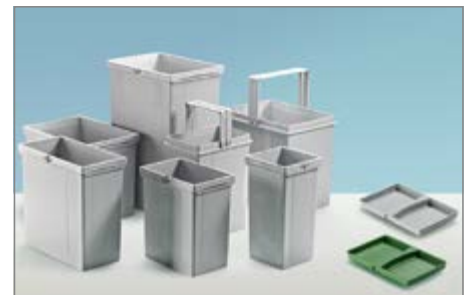

Abfallsysteme hinter Blenden für ArciTech

59

Zargenset Höhe 77 mm



Nennlänge mm	Artikelbeschreibung	Bestell-Nr. / EAN / Oberfläche / Preis			€/ 100*	ME	VPE	Kat. / Seite
		silber	weiß	anthrazit				
400	Stahl pulverbeschichtet	9255240	9255280	9255320	1.968,06	ST	1	T&A 238
		4023149450099	4023149462344	4023149481888				
450	Stahl pulverbeschichtet	9255241	9255281	9255321	1.992,42	ST	1	T&A 238
		4023149450129	4023149462450	4023149481970				
500	Stahl pulverbeschichtet	9255242	9255282	9255322	2.016,78	ST	1	T&A 238
		4023149450181	4023149462542	4023149482076				
550	Stahl pulverbeschichtet	9255243	9255283	9255323	2.041,15	ST	1	T&A 238
		4023149450228	4023149463730	4023149482106				

Zargenset Höhe 101 mm



Nennlänge mm	Artikelbeschreibung	Bestell-Nr. / EAN / Oberfläche / Preis			€/ 100*	ME	VPE	Kat. / Seite
		silber	weiß	anthrazit				
270	Stahl pulverbeschichtet	9255244	9255284	9255324	1.966,73	ST	1	T&A 240
		4023149451324	4023149464041	4023149482182				
300	Stahl pulverbeschichtet	9255245	9255285	9255325	1.981,34	ST	1	T&A 240
		4023149451355	4023149464294	4023149482250				
350	Stahl pulverbeschichtet	9255246	9255286	9255326	2.005,70	ST	1	T&A 240
		4023149451423	4023149464324	4023149482427				
400	Stahl pulverbeschichtet	9255247	9255287	9255327	2.030,06	ST	1	T&A 240
		4023149451522	4023149464744	4023149482441				
450	Stahl pulverbeschichtet	9255248	9255288	9255328	2.054,43	ST	1	T&A 240
		4023149451744	4023149464768	4023149482526				
500	Stahl pulverbeschichtet	9255249	9255289	9255329	2.078,78	ST	1	T&A 240
		4023149451775	4023149466632	4023149482564				
550	Stahl pulverbeschichtet	9255250	9255290	9255330	2.103,14	ST	1	T&A 240
		4023149451829	4023149466892	4023149482601				
600	Stahl pulverbeschichtet	9255251	9255291	9255331	2.139,89	ST	1	T&A 240
		4023149452154	4023149466915	4023149482649				
650	Stahl pulverbeschichtet	9255252	9255292	9255332	2.189,85	ST	1	T&A 240
		4023149452246	4023149466984	4023149482687				

Zargenset Höhe 139 mm



Nennlänge mm	Artikelbeschreibung	Bestell-Nr. / EAN / Oberfläche / Preis			€/ 100*	ME	VPE	Kat. / Seite
		silber	weiß	anthrazit				
300	Stahl pulverbeschichtet	9255254	9255294	9255334	2.388,37	ST	1	T&A 242
		4023149452437	4023149467509	4023149482731				
350	Stahl pulverbeschichtet	9255255	9255295	9255335	2.419,08	ST	1	T&A 242
		4023149455971	4023149467547	4023149482762				
400	Stahl pulverbeschichtet	9255256	9255296	9255336	2.449,79	ST	1	T&A 242
		4023149456176	4023149467578	4023149482830				
450	Stahl pulverbeschichtet	9255257	9255297	9255337	2.480,51	ST	1	T&A 242
		4023149456268	4023149467639	4023149482878				
500	Stahl pulverbeschichtet	9255258	9255298	9255338	2.511,21	ST	1	T&A 242
		4023149456534	4023149468308	4023149483035				
550	Stahl pulverbeschichtet	9255259	9255299	9255339	2.541,92	ST	1	T&A 242
		4023149456626	4023149468766	4023149483264				
600	Stahl pulverbeschichtet	9255260	9255300	9255340	2.588,26	ST	1	T&A 242
		4023149456671	4023149470011	4023149483462				

Doppelwandiges Schubkastensystem AvanTech YOU

Zargenset Höhe 187 mm

Nennlänge mm	Artikelbeschreibung	Bestell-Nr. / EAN / Oberfläche / Preis			ME	VPE	Kat. / Seite	
		silber	weiß	anthrazit				€ / 100*
270	Stahl pulverbeschichtet	9255262	9255302	9255342	2.964,92	ST	1	T&A 244
		4023149456855	4023149472664	4023149483967				
300	Stahl pulverbeschichtet	9255263	9255303	9255343	2.988,61	ST	1	T&A 244
		4023149457043	4023149472725	4023149484032				
350	Stahl pulverbeschichtet	9255264	9255304	9255344	3.028,08	ST	1	T&A 244
		4023149457289	4023149472879	4023149484070				
400	Stahl pulverbeschichtet	9255265	9255305	9255345	3.067,56	ST	1	T&A 244
		4023149457364	4023149473692	4023149484094				
450	Stahl pulverbeschichtet	9255266	9255306	9255346	3.107,04	ST	1	T&A 244
		4023149457821	4023149473739	4023149484445				
500	Stahl pulverbeschichtet	9255267	9255307	9255347	3.146,52	ST	1	T&A 244
		4023149457852	4023149476976	4023149485213				
550	Stahl pulverbeschichtet	9255268	9255308	9255348	3.185,98	ST	1	T&A 244
		4023149461064	4023149478314	4023149485244				
600	Stahl pulverbeschichtet	9255269	9255309	9255349	3.245,54	ST	1	T&A 244
		4023149461118	4023149479038	4023149485305				
650	Stahl pulverbeschichtet	9255270	9255310	9255350	3.326,50	ST	1	T&A 244
		4023149461385	4023149479250	4023149485442				

Zargenset Höhe 251 mm

Nennlänge mm	Artikelbeschreibung	Bestell-Nr. / EAN / Oberfläche / Preis			ME	VPE	Kat. / Seite	
		silber	weiß	anthrazit				€ / 100*
350	Stahl pulverbeschichtet	9255273	9255313	9255353	4.306,53	ST	1	T&A 246
		4023149461828	4023149480843	4023149485695				
400	Stahl pulverbeschichtet	9255274	9255314	9255354	4.368,00	ST	1	T&A 246
		4023149461897	4023149481468	4023149485848				
450	Stahl pulverbeschichtet	9255275	9255315	9255355	4.429,46	ST	1	T&A 246
		4023149461927	4023149481574	4023149486197				
500	Stahl pulverbeschichtet	9255276	9255316	9255356	4.490,91	ST	1	T&A 246
		4023149462030	4023149481642	4023149486470				
550	Stahl pulverbeschichtet	9255277	9255317	9255357	4.552,38	ST	1	T&A 246
		4023149462078	4023149481741	4023149486500				
600	Stahl pulverbeschichtet	9255278	9255318	9255358	4.645,09	ST	1	T&A 246
		4023149462122	4023149481772	4023149486616				
650	Stahl pulverbeschichtet	9255279	9255319	9255359	4.771,14	ST	1	T&A 246
		4023149462191	4023149481826	4023149486739				

Stabilisator Rückwand



Artikelbeschreibung	EAN	Bestell-Nr. / Preis	ME	VPE	Kat. / Seite	
		€ / 100*				
Universalwinkel 31 x 31 mm für Holzrückwand Höhe 77 mm, Kunststoff	4023149796654	0079665	46,86	ST	1	T&A 238
für Holz- und Aluminiumrückwände, Kunststoff	4023149600326	9257702	46,50	ST	1	T&A 240

Frontstabilisator



Artikelbeschreibung	EAN	Bestell-Nr. / Preis	ME	VPE	Kat. / Seite	
		€ / 100*				
ab Korpusbreite 600 mm	4023149036934	9123080	77,75	ST	1	T&A 258

Weitere Informationen finden Sie hier:
hettich.com/short/a07bc8



Unverbindliche Preisempfehlung. Preise gültig bei Abnahme von ganzen Verpackungseinheiten zzgl. MwSt.

Innenfrontprofil zum Selbstablängen, Länge 2000 mm

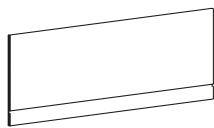

Nennlänge mm	Artikelbeschreibung	Bestell-Nr. / EAN / Oberfläche / Preis				ME	VPE	Kat. / Seite
		silber	weiß	anthrazit	€ / 100*			
101	Aluminium pulverbeschichtet	9257269	9257273	9257277	4.975,50	ST	1	T&A 252
		4023149743740	4023149746284	4023149746802				
139	Aluminium pulverbeschichtet	9257270	9257274	9257278	5.952,00	ST	1	T&A 252
		4023149743832	4023149746376	4023149747205				
187	Aluminium pulverbeschichtet	9257271	9257275	9257279	7.440,00	ST	1	T&A 252
		4023149744716	4023149746444	4023149747700				

Set Verbinder für Innenfrontprofil zum Selbstablängen, Nutzung mit Zarge

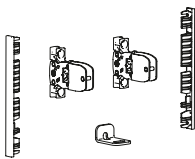

Nennlänge mm	Artikelbeschreibung	Bestell-Nr. / EAN / Oberfläche / Preis				ME	VPE	Kat. / Seite
		silber	weiß	anthrazit	€ / 100*			
101	Stahl / Kunststoff	9257611	9257615	9257619	220,44	ST	1	T&A 252
		4023149501159	4023149510670	4023149521683				
139	Stahl / Kunststoff	9257612	9257616	9257620	291,92	ST	1	T&A 252
		4023149504150	4023149512780	4023149522895				
187	Stahl / Kunststoff	9257613	9257617	9257621	426,35	ST	1	T&A 252
		4023149508301	4023149518300	4023149523243				

Trägerprofil für gestaltbare Innenfront



Nennlänge mm	Artikelbeschreibung	Bestell-Nr. / EAN / Oberfläche / Preis				ME	VPE	Kat. / Seite
		silber	weiß	anthrazit	€ / 100*			
2000	Aluminium pulverbeschichtet	9257663	9257664	9257665	2.546,21	ST	1	T&A 254
		4023149569906	4023149570056	4023149571190				

Set Verbinder für gestaltbare Front, Nutzung mit Zarge

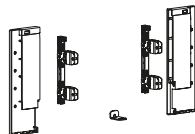

Höhe mm	Artikelbeschreibung	Bestell-Nr. / EAN / Oberfläche / Preis				ME	VPE	Kat. / Seite
		silber	weiß	anthrazit	€ / 100*			
187	Stahl pulverbeschichtet	9257651	9257652	9257653	1.722,33	ST	1	T&A 254
		4023149555350	4023149555930	4023149559051				

Mitnehmer für Innenfrontprofil

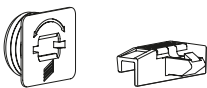

Artikelbeschreibung	Bestell-Nr. / EAN / Oberfläche / Preis				ME	VPE	Kat. / Seite
	silber	weiß	anthrazit	€ / 100*			
Kunststoff	9257734	9257735	9257736	488,25	ST	1	T&A 253
	4023149639746	4023149639838	4023149640681				

DesignProfil in Akzentfarbe, Kunststoff foliert



Nennlänge mm	Bestell-Nr. / EAN / Oberfläche / Preis					ME	VPE	Kat. / Seite	
	Aluminium	Edelstahl	Chrom	Eiche	Nussbaum				€ / 100*
500	9255764	9255773	9255782	9255791	9255800	53,70	ST	1	T&A 256
	4023149681547	4023149684821	4023149687860	4023149692383	4023149695780				

Gestaltbares DesignProfil, Kunststoff grau mit Klebestreifen



Nennlänge mm	Bestell-Nr. / EAN / Preis		ME	VPE	Kat. / Seite
		€ / 100*			
2000	9255831	174,38	ST	1	T&A 256
	4023149707421				

DesignCape zum Aufelipsen, 2000 mm

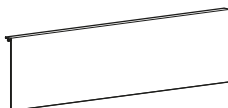

Nennlänge mm	Artikelbeschreibung	Bestell-Nr. / EAN / Oberfläche / Preis			ME	VPE	Kat. / Seite	
		Aluminium Optik	/ 100*	Edelstahl Optik				€ / 100*
101	Aluminium	9257643	5.027,03	9257647	7.148,44	ST	1	T&A 257
		4023149550041		4023149552700				
187	Aluminium	9257645	8.294,60	9257649	11.114,76	ST	1	T&A 257
		4023149551376		4023149553707				

Doppelwandiges Schubkastensystem AvanTech YOU

Brandingclip mit Hettich Logo



Artikelbeschreibung	Bestell-Nr. / EAN / Oberfläche / Preis			ME	VPE	Kat. / Seite
	silber	weiß	anthrazit			
zum Aufklipsen, Kunststoff foliert	9257703 4023149600852	9257704 4023149601132	9257705 4023149601842	17,41	ST	1 T&A 257

Auszugsführung Actro YOU mit Silent System

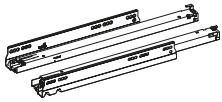

Nennlänge mm	Artikelbeschreibung	Bestell-Nr. / EAN / Belastungsklasse / Preis			ME	VPE	Kat. / Seite
		XS (10 kg)	EAN	€/ 100*			
270	Stahl verzinkt	9256968	4023149954184	1.965,50	ST	1 T&A 260	
300	Stahl verzinkt	9256969	4023149954269	1.965,50	ST	1 T&A 260	
350	Stahl verzinkt	9256971	4023149954566	1.965,50	ST	1 T&A 260	
Nennlänge mm	Artikelbeschreibung	Bestell-Nr. / EAN / Belastungsklasse / Preis			ME	VPE	Kat. / Seite
		L (40 kg)	EAN	€/ 100*			
270	Stahl verzinkt	9256999	4023149959523	1.965,50	ST	1 T&A 260	
300	Stahl verzinkt	9257000	4023149959646	1.965,50	ST	1 T&A 260	
350	Stahl verzinkt	9257002	4023149959844	1.965,50	ST	1 T&A 260	
400	Stahl verzinkt	9257004	4023149960284	1.987,30	ST	1 T&A 260	
450	Stahl verzinkt	9257006	4023149961021	2.008,93	ST	1 T&A 260	
500	Stahl verzinkt	9257008	4023149962967	2.030,73	ST	1 T&A 260	
550	Stahl verzinkt	9257010	4023149963315	2.146,83	ST	1 T&A 260	
600	Stahl verzinkt	9268681	4023149191626	2.172,54	ST	1 T&A 260	
Nennlänge mm	Artikelbeschreibung	Bestell-Nr. / EAN / Belastungsklasse / Preis			ME	VPE	Kat. / Seite
		XL (70 kg)	EAN	€/ 100*			
450	Stahl verzinkt	9257034	4023149972027	2.213,11	ST	1 T&A 260	
500	Stahl verzinkt	9257036	4023149974991	2.233,04	ST	1 T&A 260	
550	Stahl verzinkt	9257038	4023149977831	2.339,16	ST	1 T&A 260	
600	Stahl verzinkt	9257040	4023149979835	2.553,49	ST	1 T&A 260	
650	Stahl verzinkt	9257041	4023149980312	2.650,22	ST	1 T&A 260	

Öffnungssystem Push to open Silent für Actro YOU

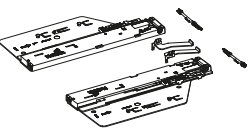

Nennlänge mm	Gesamt- gewicht kg	Actro kg	Bestell-Nr. / EAN / Preis			ME	VPE	Kat. / Seite
					€/ 100*			
270 - 350	< 10	10	9257890	4023149191473	1.928,00	ST	1 T&A 262	
270 - 650	8 - 20	40	9257891	4023149191534	1.928,00	ST	1 T&A 262	
270 - 650	10 - 40	40	9257892	4023149191480	1.928,00	ST	1 T&A 262	
400 - 650	20 - 70	70	9257893	4023149191497	1.928,00	ST	1 T&A 262	

Optionale Synchronisation für Push to open Silent

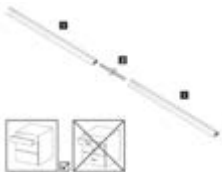

Artikelbeschreibung	Bestell-Nr. / EAN / Preis			ME	VPE	Kat. / Seite
	Empfohlen für Korpusbreiten > 600 mm / Länge 2000 mm					
1 Synchronisationsstange, Aluminium eloxiert	9236718	4023149089336	628,74	ST	1	T&A 263
2 Verbinder	9221295	4023149064234	56,96	ST	1	T&A 263

Unverbindliche Preisempfehlung. Preise gültig bei Abnahme von ganzen Verpackungseinheiten zzgl. MwSt.

Optionale Multi-Synchronisation für Push to open Silent

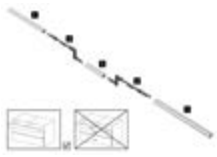

Artikelbeschreibung Empfohlen für Korpusbreiten > 600 mm / Länge 2000 mm	Bestell-Nr. / EAN / Preis		ME	VPE	Kat. / Seite
		€ / 100*			
2 Verbinder, Aluminium eloxiert, Kunststoff grau	9278452 4023149217869	148,89	ST	1	T&A 263

Optionaler flexibler Adapter für Synchronisation



Artikelbeschreibung Empfohlen für Korpusbreiten > 600 mm / Länge 2000 mm	Bestell-Nr. / EAN / Preis		ME	VPE	Kat. / Seite
		€ / 100*			
Zum Einsatz bei tiefenversetzten Auszugsführungen (schrägen Fronten)	9262213 4023149179310	280,94	ST	1	T&A 263

Optionale Umlenkung Synchronisation für Push to open Silent

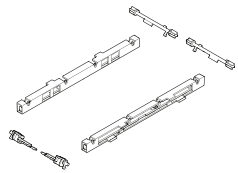

Artikelbeschreibung	Bestell-Nr. / EAN / Preis		ME	VPE	Kat. / Seite
		€ / 100*			
Zur Verlegung der Synchronisationsstange um 80, 90 oder 140 mm	9278453 4023149217876	3.304,00	ST	1	T&A 263

Direktbefestigungsschrauben



Artikelbeschreibung	Bestell-Nr. / EAN / Preis		ME	VPE	Kat. / Seite
		€ / 100*			
Senkkopf, PZ-Kreuzschlitz, Stahl vernickelt, ø 6 x 14	9137114 4023149071638	9,16	ST	1	T&A 263
Senkkopf, PZ-Kreuzschlitz, Stahl verzinkt, ø 6,3 x 14	0051265 4023149512650	4,90	ST	1	T&A 263



OrgaTray 440

- für Schubkästen / Innenschubkästen
- für AvanTech YOU / ArciTech

44



OrgaTray 630

- für Schubkästen / Innenschubkästen
- für AvanTech YOU / ArciTech

44



OrgaStripe

- für Schubkästen / Innenschubkästen
- für AvanTech YOU / ArciTech

44

Innenorganisation für Schubkästen und Innenschubkästen

► Für Schubkastensysteme AvanTech YOU

OrgaTray 440



Breite mm	Tiefe mm	Bestell-Nr. / EAN / Farbe / Preis			ME	VPE	Kat. / Seite
		silber	EAN	€/ 100*			
251 - 300	441 - 520	9194932	4023149740367	1.033,09	ST	1	T&A 318
301 - 350	441 - 520	9194933	4023149740404	1.102,50	ST	1	T&A 318
351 - 400	441 - 520	9194934	4023149740480	1.171,91	ST	1	T&A 318
401 - 450	441 - 520	9194935	4023149741142	1.241,31	ST	1	T&A 318
451 - 500	441 - 520	9194936	4023149741654	1.310,72	ST	1	T&A 318
501 - 600	441 - 520	9194937	4023149741869	1.449,53	ST	1	T&A 318
601 - 700	441 - 520	9194938	4023149741890	2.589,40	ST	1	T&A 318
701 - 800	441 - 520	9194939	4023149742101	2.728,22	ST	1	T&A 318
801 - 900	441 - 520	9194940	4023149742170	2.867,04	ST	1	T&A 318
Breite mm	Tiefe mm	Bestell-Nr. / EAN / Farbe / Preis			ME	VPE	Kat. / Seite
		anthrazit	EAN	€/ 100*			
401 - 450	441 - 520	9194997	4023149751486	1.241,31	ST	1	T&A 318
451 - 500	441 - 520	9194998	4023149751790	1.310,72	ST	1	T&A 318
501 - 600	441 - 520	9194999	4023149751868	1.449,53	ST	1	T&A 318
601 - 700	441 - 520	9195000	4023149752261	2.589,40	ST	1	T&A 318
701 - 800	441 - 520	9195001	4023149752285	2.728,22	ST	1	T&A 318
801 - 900	441 - 520	9195002	4023149752322	2.867,04	ST	1	T&A 318

OrgaTray 630



Länge mm	Artikelbeschreibung	Bestell-Nr. / EAN / Farbe / Preis				ME	VPE	Kat. / Seite
		silber	weiß	anthrazit	€/ 100*			
500	Stahl pulverbeschichtet	9278316 4023149217401	9278332 4023149217463	9278319 4023149217432	4.209,04	ST	1	T&A 322

OrgaStripe Profil

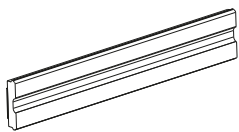

Länge mm	Artikelbeschreibung	Bestell-Nr. / EAN / Farbe / Preis				ME	VPE	Kat. / Seite
		grau	weiß	schwarz	€/ 100*			
1100	Kunststoff	9203466 4023149772757	9203465 4023149517167	9203254 4023149517150	337,28	ST	1	T&A 323

OrgaStripe Clip

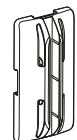

Artikelbeschreibung	Bestell-Nr. / EAN / Farbe / Preis				ME	VPE	Kat. / Seite
	grau	weiß	schwarz	€/ 100*			
Kunststoff	9203469 4023149517181	9203468 4023149960000	9203467 4023149790171	77,57	ST	1	T&A 323

AvanTech Pull Rahmen, Eimer, Deckel, Fußpedal

AvanTech Pull Rahmen



Nennlänge mm	Artikelbeschreibung	Bestell-Nr. / EAN / Preis			ME	VPE	Kat. /Seite
				€ / 100*			
500	Korpusbreite 600 mm	9278336	4023149217500	16.176,53	ST	1	T&A 884
500	Korpusbreite 600 mm für 2 x 40L	9278337	4023149217517	16.823,61	ST	1	T&A 884

Eimer



Artikelbeschreibung	Bestell-Nr. / EAN / Preis			ME	VPE	Kat. /Seite
			€ / 100*			
8 l, anthrazit, 152 x 225 x 295 mm	9279390	4023149225123	1.027,48	ST	1	T&A 885
11 l, anthrazit, 152 x 304 x 295 mm	9279391	4023149225130	1.109,67	ST	1	T&A 885
17 l, anthrazit, 225 x 304 x 295 mm	9279392	4023149225147	1.150,77	ST	1	T&A 885
29 l, anthrazit, 225 x 304 x 460 mm	9279393	4023149225154	3.082,41	ST	1	T&A 885
42 l, anthrazit, 223 x 418 x 505 mm	9279394	4023149225161	6.404,02	ST	1	T&A 885

Deckel



Artikelbeschreibung	Bestell-Nr. / EAN / Preis			ME	VPE	Kat. /Seite
			€ / 100*			
8 l, anthrazit, 152 x 225 x 21 mm	9279396	4023149225185	1.109,67	ST	1	T&A 885
11 l, anthrazit, 152 x 304 x 21 mm	9279397	4023149225192	1.571,07	ST	1	T&A 885
17 / 29 l, anthrazit, 225 x 304 x 21 mm	9279398	4023149225208	1.282,28	ST	1	T&A 885
40 l, anthrazit, 223 x 418 x 21 mm	9279399	4023149225215	2.942,56	ST	1	T&A 885

Fußpedal



Artikelbeschreibung	Bestell-Nr. / EAN / Preis			ME	VPE	Kat. /Seite
			€ / 100*			
Passend für AvanTech Pull, Edelstahl	9111679	4023149050718	5.667,56	ST	1	T&A 888

Unverbindliche Preisempfehlung. Preise gültig bei Abnahme von ganzen Verpackungseinheiten zzgl. MwSt.

Schubkastensysteme

► ArciTech Flexible Sets

Flexible Sets

Einfache Bestellung, einfache Montage und hohe Flexibilität: Die wirtschaftliche Schubkastenlösung in nur **vier Schritten**. Nutzen Sie die wirtschaftlichen Vorteile der Stahlrückwand für Standardkorpusbreiten!



Flexible Sets

Beispiel:

Frontauszug in Silber mit Längsreling, Systemhöhe 186 mm, Zargenhöhe 94 mm, Nennlänge 500 mm, Stahlrückwand, Korpusbreite 600 mm, Actro 40 kg mit Silent System für Korpusseitendicke 16 mm.

1. Auswahl der Zarge inklusive der Höhe, Nennlänge und Oberflächenfarbe
2. Rückwandart / Systemhöhe
3. Seitenelement bei Frontauszügen
4. Art der Führung

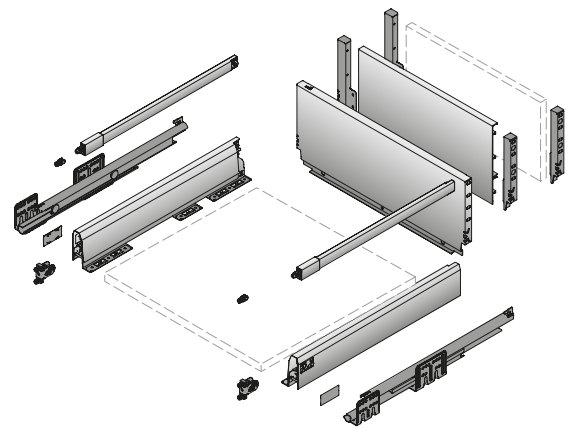

1. Set Zargen

Lieferumfang:

- 1 Stück Zarge links / rechts
- 2 Stück Frontbefestigungen für Zarge zum Einschlagen
- 2 Stück Abdeckkappen Kunststoff mit Hettich Logo
- Befestigungsmaterial



Nennlänge mm	Bestell-Nr.	VE
270	9150613	1 Set
300	9150614	1 Set
350	9150615	1 Set
400	9150616	1 Set
450	9150618	1 Set
500	9150619	1 Set
550	9150620	1 Set
650	9150621	1 Set

2. Stahlrückwand

- Für Standardkorpusbreite



Korpusbreite mm	Bestell-Nr.	VE
275	9121505	1/10 St.
300	9121506	1/10 St.
350	9121508	1/10 St.
400	9121510	1/10 St.
450	9121512	1/10 St.
500	9121514	1/10 St.
550	9121516	1/10 St.
600	9121518	1/10 St.
700	9121520	1/10 St.
800	9121522	1/10 St.
900	9121524	1/10 St.
1000	9121526	1/10 St.
1200	9121530	1/10 St.

3. Set Längsreling

Lieferumfang:

- 1 Stück Längsreling, links und rechts
- 2 Stück Frontbefestigungen für Längsreling zum Einschlagen



Nennlänge mm	Bestell-Nr.	VE
270	9150647	1 Set
300	9150648	1 Set
350	9150649	1 Set
400	9150650	1 Set
450	9150652	1 Set
500	9150653	1 Set
550	9150654	1 Set
650	9150656	1 Set

4. Auszugsführung Actro

Lieferumfang:

- 1 Stück Actro links / rechts
- Befestigungsmaterial



Nennlänge mm	Bestell-Nr.	VE
270	9149234	1 Set
300	9149235	1 Set
350	9149236	1 Set
400	9149237	1 Set
450	9149238	1 Set
500	9149239	1 Set
550	9149240	1 Set

Unverbindliche Preisempfehlung. Preise gültig bei Abnahme von ganzen Verpackungseinheiten zzgl. MwSt.

Doppelwandiges Schubkastensystem ArciTech

ArciTech Set Zarge und Rückwandverbinder, Höhe 78 mm



Artikelbeschreibung	Bestell-Nr. / Farbe / EAN / Preis			ME	VPE	Kat. / Seite
	silber	EAN	€ / 100*			
Zarge, Nennlänge 500 mm, Stahl pulverbeschichtet	9234469	4023149086731	1.996,25	ST	1	T&A 272
Rückwandverbinder für Holz oder Aluminium	9150630	4023149169182	388,73	ST	1	T&A 272

ArciTech Set Zarge, Höhe 94 mm



Nennlänge mm	Artikelbeschreibung	Bestell-Nr. / Farbe / EAN / Preis			ME	VPE	Kat. / Seite
		silber	EAN	€ / 100*			
270	Stahl pulverbeschichtet	9150613	4023149169021	1.465,20	ST	1	T&A 274
300	Stahl pulverbeschichtet	9150614	4023149169038	1.475,97	ST	1	T&A 274
350	Stahl pulverbeschichtet	9150615	4023149169045	1.493,91	ST	1	T&A 274
400	Stahl pulverbeschichtet	9150616	4023149169052	1.511,83	ST	1	T&A 274
450	Stahl pulverbeschichtet	9150618	4023149169069	1.529,78	ST	1	T&A 274
500	Stahl pulverbeschichtet	9150619	4023149169076	1.547,73	ST	1	T&A 274
550	Stahl pulverbeschichtet	9150620	4023149169083	1.565,67	ST	1	T&A 274
650	Stahl pulverbeschichtet	9150621	4023149169090	1.601,54	ST	1	T&A 274

ArciTech Set Rückwandverbinder, Höhe 94 mm



Artikelbeschreibung	Bestell-Nr. / Farbe / EAN / Preis			ME	VPE	Kat. / Seite
	silber	EAN	€ / 100*			
für Holz oder Aluminium	9150641	4023149169199	388,73	ST	1	T&A 274

Stahlrückwand ArciTech, Höhe 94 mm



Artikelbeschreibung	Bestell-Nr. / Farbe / EAN / Preis			ME	VPE	Kat. / Seite
	silber	EAN	€ / 100*			
Korpusbreite 600 mm	9121362	4023149047855	344,62	ST	20	.

Aluminiumrückwand ArciTech, Höhe 94 mm



Artikelbeschreibung	Bestell-Nr. / Farbe / EAN / Preis			ME	VPE	Kat. / Seite
	silber	EAN	€ / 100*			
Länge 2000 mm	9192200	4023149967825	5.382,35	ST	1	T&A 314

ArciTech Front für Innenschubkasten, Höhe 94 mm



Artikelbeschreibung	Bestell-Nr. / Farbe / EAN / Preis			ME	VPE	Kat. / Seite
	silber	EAN	€ / 100*			
Korpusbreite 600 mm	9122799	4023149037993	1.813,98	ST	1	.

ArciTech Aluminiumfront für Innenschubkasten, Höhe 94 mm



Artikelbeschreibung	Bestell-Nr. / Farbe / EAN / Preis			ME	VPE	Kat. / Seite
	silber	EAN	€ / 100*			
Nennlänge 2000 mm	9192204	4023149968204	3.468,63	ST	1	T&A 306

ArciTech Verbinder für Front, Höhe 94 mm



Artikelbeschreibung	Bestell-Nr. / Farbe / EAN / Preis			ME	VPE	Kat. / Seite
	silber	EAN	€ / 100*			
Links / rechts	9123083	4023149037504	956,86	ST	1	T&A 306



Weitere Informationen finden Sie hier:
hettich.com/short/7d5f1e

Doppelwandiges Schubkastensystem ArciTech

ArciTech Set Zarge, Höhe 126 mm



Nennlänge mm	Artikelbeschreibung	Bestell-Nr. / Farbe / EAN / Preis			ME	VPE	Kat. / Seite
		silber	EAN	€ / 100*			
270	Stahl pulverbeschichtet	9150622	4023149169106	1.764,22	ST	1	T&A 276
300	Stahl pulverbeschichtet	9150623	4023149169113	1.774,98	ST	1	T&A 276
350	Stahl pulverbeschichtet	9150624	4023149169120	1.792,93	ST	1	T&A 276
400	Stahl pulverbeschichtet	9150625	4023149169137	1.810,86	ST	1	T&A 276
450	Stahl pulverbeschichtet	9150626	4023149169144	1.828,80	ST	1	T&A 276
500	Stahl pulverbeschichtet	9150627	4023149169151	1.846,74	ST	1	T&A 276
550	Stahl pulverbeschichtet	9150628	4023149169168	1.864,68	ST	1	T&A 276
650	Stahl pulverbeschichtet	9150629	4023149169175	1.900,57	ST	1	T&A 276

ArciTech Set Rückwandverbinder, Höhe 126 mm



Artikelbeschreibung	Bestell-Nr. / Farbe / EAN / Preis			ME	VPE	Kat. / Seite
	silber	EAN	€ / 100*			
für Holz oder Aluminium	9150642	4023149169205	493,38	ST	1	T&A 276

Aluminiumrückwand ArciTech, Höhe 126 mm



Artikelbeschreibung	Bestell-Nr. / Farbe / EAN / Preis			ME	VPE	Kat. / Seite
	silber	EAN	€ / 100*			
Länge 2000 mm	9192194	4023149966064	6.147,83	ST	1	T&A 314

ArciTech Aluminiumfront für Innenschubkasten, Höhe 126 mm



Artikelbeschreibung	Bestell-Nr. / Farbe / EAN / Preis			ME	VPE	Kat. / Seite
	silber	EAN	€ / 100*			
Nennlänge 2000 mm	9192204	4023149968204	3.468,63	ST	1	T&A 306

ArciTech Verbinder für Front, Höhe 126 mm



Artikelbeschreibung	Bestell-Nr. / Farbe / EAN / Preis			ME	VPE	Kat. / Seite
	silber	EAN	€ / 100*			
Links / rechts	9123086	4023149037511	1.225,99	ST	1	T&A 306

ArciTech Set Rückwandverbinder, Höhe 186 mm



Artikelbeschreibung	Bestell-Nr. / Farbe / EAN / Preis			ME	VPE	Kat. / Seite
	silber	EAN	€ / 100*			
für Holz oder Aluminium	9150643	4023149169212	627,94	ST	1	T&A 278

Stahlrückwand ArciTech, Höhe 186 mm



Artikelbeschreibung	Bestell-Nr. / Farbe / EAN / Preis			ME	VPE	Kat. / Seite
	silber	EAN	€ / 100*			
Korpusbreite 600 mm	9121518	4023149048111	605,89	ST	1	.

Unverbindliche Preisempfehlung. Preise gültig bei Abnahme von ganzen Verpackungseinheiten zzgl. MwSt.

Doppelwandiges Schubkastensystem ArciTech

Aluminiumrückwand ArciTech, Höhe 186 mm



Artikelbeschreibung	Bestell-Nr. / Farbe / EAN / Preis			ME	VPE	Kat./Seite
	silber		€/ 100*			
Länge 2000 mm	9192189	4023149965906	7.583,12	ST	1	T&A 314

ArciTech Aluminiumfront



Artikelbeschreibung	Bestell-Nr. / Farbe / EAN / Preis			ME	VPE	Kat./Seite
	silber		€/ 100*			
Nennlänge 2000 mm	9192204	4023149968204	3.468,63	ST	1	T&A 306

ArciTech Verbinder für Front, Höhe 186 mm



Artikelbeschreibung	Bestell-Nr. / Farbe / EAN / Preis			ME	VPE	Kat./Seite
	silber		€/ 100*			
Links / rechts	9123089	4023149037528	1.734,31	ST	1	T&A 306

OrgaStore 400 Individuelle Breite



Artikelbeschreibung	Bestell-Nr. / Farbe / EAN / Preis			ME	VPE	Kat./Seite
	silber		€/ 100*			
Nennlänge 2000 mm	9182706	4023149855306	1.047,69	ST	1	T&A 306

ArciTech Set Rückwandverbinder, Höhe 218 mm



Artikelbeschreibung	Bestell-Nr. / Farbe / EAN / Preis			ME	VPE	Kat./Seite
	silber		€/ 100*			
für Holz oder Aluminium	9150644	4023149169229	723,62	ST	1	T&A 282

Aluminiumrückwand ArciTech, Höhe 186 mm



Artikelbeschreibung	Bestell-Nr. / Farbe / EAN / Preis			ME	VPE	Kat./Seite
	silber		€/ 100*			
Länge 2000 mm	9192182	4023149965753	8.348,63	ST	1	T&A 314

ArciTech Set Längsreling



Nennlänge mm	Artikelbeschreibung	Bestell-Nr. / Farbe / EAN / Preis			ME	VPE	Kat./Seite
		silber		€/ 100*			
270	Stahl pulverbeschichtet	9150647	4023149169250	655,58	ST	1	T&A 278
300	Stahl pulverbeschichtet	9150648	4023149169267	664,55	ST	1	T&A 278
350	Stahl pulverbeschichtet	9150649	4023149169274	679,49	ST	1	T&A 278
400	Stahl pulverbeschichtet	9150650	4023149169281	694,45	ST	1	T&A 278
450	Stahl pulverbeschichtet	9150652	4023149169298	709,40	ST	1	T&A 278
500	Stahl pulverbeschichtet	9150653	4023149169304	724,35	ST	1	T&A 278
550	Stahl pulverbeschichtet	9150654	4023149169311	739,30	ST	1	T&A 278
650	Stahl pulverbeschichtet	9150656	4023149169328	769,20	ST	1	T&A 278

Frontbefestigung zum Anschrauben für Längsreling



Artikelbeschreibung	Bestell-Nr. / Farbe / EAN / Preis			ME	VPE	Kat./Seite
	anthrazit		€/ 100*			
Kunststoff	9127011	4023149036965	11,96	ST	1	T&A 314

Doppelwandiges Schubkastensystem ArciTech

ArciTech TopSide, Höhe 92 mm



Artikelbeschreibung	Bestell-Nr. / Farbe / EAN / Preis			ME	VPE	Kat. / Seite
	silber		€ / 100*			
Nennlänge 500 mm	9122920	4023149049590	2.249,69	ST	1	T&A 278

ArciTech DesignSide Glas, Höhe 92 mm



Artikelbeschreibung	Bestell-Nr. / Farbe / EAN / Preis			ME	VPE	Kat. / Seite
			€ / 100*			
Nennlänge 500 mm	9122988	4023149034954	1.717,06	ST	1	T&A 278

ArciTech DesignSide Adapter, Höhe 92 mm



Artikelbeschreibung	Bestell-Nr. / Farbe / EAN / Preis			ME	VPE	Kat. / Seite
			€ / 100*			
silber	9122973	4023149034862	1.196,08	ST	1	T&A 278

ArciTech TopSide, Höhe 124 mm



Artikelbeschreibung	Bestell-Nr. / Farbe / EAN / Preis			ME	VPE	Kat. / Seite
	silber		€ / 100*			
Nennlänge 500 mm	9122957	4023149049644	2.646,79	ST	1	T&A 282

ArciTech DesignSide Glas, Höhe 124 mm



Artikelbeschreibung	Bestell-Nr. / Farbe / EAN / Preis			ME	VPE	Kat. / Seite
			€ / 100*			
Nennlänge 500 mm	9122996	4023149035890	2.252,91	ST	1	T&A 282

ArciTech DesignSide Adapter, Höhe 124 mm



Artikelbeschreibung	Bestell-Nr. / Farbe / EAN / Preis			ME	VPE	Kat. / Seite
			€ / 100*			
silber	9122978	4023149034879	1.794,11	ST	1	T&A 282

ArciTech Frontstabilisator



Artikelbeschreibung	Bestell-Nr. / Farbe / EAN / Preis			ME	VPE	Kat. / Seite
			€ / 100*			
ab Korpusbreite 600 mm	9123080	4023149036934	77,75	ST	1	T&A 258

Frontbefestigung zum Anschrauben für Zarge

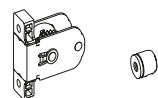

Artikelbeschreibung	Bestell-Nr. / Farbe / EAN / Preis			ME	VPE	Kat. / Seite
	anthrazit		€ / 100*			
Kunststoff	9123011	4023149036927	104,66	ST	1	T&A 314

Unverbindliche Preisempfehlung. Preise gültig bei Abnahme von ganzen Verpackungseinheiten zzgl. MwSt.

Doppelwandiges Schubkastensystem ArciTech

OrgaTray 440



Breite mm	Tiefe mm	Bestell-Nr. / Farbe / EAN / Preis			ME	VPE	Kat. / Seite
		silber		€ / 100*			
401 - 450	370 - 440	9194922	4023149739644	1.145,21	ST	1	T&A 318
501 - 600	370 - 440	9194924	4023149739736	1.321,40	ST	1	T&A 318
251 - 300	441 - 520	9194932	4023149740367	1.033,09	ST	1	T&A 318
301 - 350	441 - 520	9194933	4023149740404	1.102,50	ST	1	T&A 318
351 - 400	441 - 520	9194934	4023149740480	1.171,91	ST	1	T&A 318
401 - 450	441 - 520	9194935	4023149741142	1.241,31	ST	1	T&A 318
451 - 500	441 - 520	9194936	4023149741654	1.310,72	ST	1	T&A 318
501 - 600	441 - 520	9194937	4023149741869	1.449,53	ST	1	T&A 318
601 - 700	441 - 520	9194938	4023149741890	2.589,40	ST	1	T&A 318
701 - 800	441 - 520	9194939	4023149742101	2.728,22	ST	1	T&A 318
801 - 900	441 - 520	9194940	4023149742170	2.867,04	ST	1	T&A 318

OrgaStripe Profil



Artikelbeschreibung	Bestell-Nr. / EAN / Preis			ME	VPE	Kat. / Seite
			€ / 100*			
grau	9203466	4023149772757	337,28	ST	1	T&A 323

OrgaClip



Artikelbeschreibung	Bestell-Nr. / EAN / Preis			ME	VPE	Kat. / Seite
			€ / 100*			
grau	9203469	4023149517181	77,57	ST	1	T&A 323

OrgaStore 400 Individuelle Breite



Artikelbeschreibung	Bestell-Nr. / Farbe / EAN / Preis			ME	VPE	Kat. / Seite
	silber		€ / 100*			
Nennlänge 2000 mm	9182706	4023149855306	1.047,69	ST	1	T&A 306

OrgaStore 400 Adapter



Artikelbeschreibung	Bestell-Nr. / EAN / Preis			ME	VPE	Kat. / Seite
			€ / 100*			
anthrazit	9182222	4023149847561	200,22	ST	1	T&A 324

OrgaStore 400 / 430 Längsteiler



Artikelbeschreibung	Bestell-Nr. / EAN / Preis			ME	VPE	Kat. / Seite
			€ / 100*			
anthrazit	9182225	4023149847691	253,60	ST	1	T&A 324

Antirutschmatte



Artikelbeschreibung	Bestell-Nr. / Farbe / EAN / Preis			ME	VPE	Kat. / Seite
	anthrazit		€ / 100*			
Nennlänge 450 x 5000 mm	9209578	4023149516726	6.203,77	ST	1	T&A 327
Nennlänge 500 x 5000 mm	9209580	4023149516764	6.377,19	ST	1	T&A 327
Nennlänge 650 x 5000 mm	9209582	4023149516818	8.711,98	ST	1	T&A 327

Doppelwandiges Schubkastensystem ArciTech

Universal Siphonausschnitt-Abdeckung



Artikelbeschreibung	Bestell-Nr. / EAN / Preis			ME	VPE	Kat. / Seite
	weiß	€ / 100*				
silber	9204282	4023149959820	1.130,14	ST	1	T&A 330
weiß	9204283	4023149785009	1.130,14	ST	1	T&A 330

ArciTech Set Zarge, Höhe 94 mm



Nennlänge mm	Artikelbeschreibung	Bestell-Nr. / Farbe / EAN / Preis			ME	VPE	Kat. / Seite
		weiß	€ / 100*				
270	Stahl pulverbeschichtet	9149261	4023149503788	1.465,20	ST	1	T&A 274
300	Stahl pulverbeschichtet	9149262	4023149503795	1.475,97	ST	1	T&A 274
350	Stahl pulverbeschichtet	9149263	4023149503801	1.493,91	ST	1	T&A 274
400	Stahl pulverbeschichtet	9149264	4023149503818	1.511,83	ST	1	T&A 274
450	Stahl pulverbeschichtet	9149265	4023149503825	1.529,78	ST	1	T&A 274
500	Stahl pulverbeschichtet	9149266	4023149503832	1.547,73	ST	1	T&A 274
550	Stahl pulverbeschichtet	9149268	4023149503849	1.565,67	ST	1	T&A 274
650	Stahl pulverbeschichtet	9149269	4023149503856	1.601,54	ST	1	T&A 274

Weitere Informationen finden Sie hier:
hettich.com/short/7d5f1e



ArciTech Set Rückwandverbinder, Höhe 94 mm



Artikelbeschreibung	Bestell-Nr. / Farbe / EAN / Preis			ME	VPE	Kat. / Seite
	weiß	€ / 100*				
für Holz oder Aluminium	9149279	4023149503580	388,73	ST	1	T&A 274

ArciTech Stahlrückwand, Höhe 94 mm



Artikelbeschreibung	Bestell-Nr. / Farbe / EAN / Preis			ME	VPE	Kat. / Seite
	weiß	€ / 100*				
Korpusbreite 600 mm	9121388	4023149048661	344,62	ST	1	.

ArciTech Aluminiumrückwand, Höhe 94 mm



Artikelbeschreibung	Bestell-Nr. / Farbe / EAN / Preis			ME	VPE	Kat. / Seite
	weiß	€ / 100*				
Länge 2000 mm	9192202	4023149438158	5.382,35	ST	1	T&A 314

ArciTech Aluminiumfront



Artikelbeschreibung	Bestell-Nr. / Farbe / EAN / Preis			ME	VPE	Kat. / Seite
	weiß	€ / 100*				
Länge 2000 mm	9192206	4023149968303	3.468,63	ST	1	T&A 306

ArciTech Verbinder für Front, Höhe 94 mm



Artikelbeschreibung	Bestell-Nr. / Farbe / EAN / Preis			ME	VPE	Kat. / Seite
	weiß	€ / 100*				
Links / rechts	9123084	4023149037542	956,86	ST	1	T&A 306

Unverbindliche Preisempfehlung. Preise gültig bei Abnahme von ganzen Verpackungseinheiten zzgl. MwSt.

Doppelwandiges Schubkastensystem ArciTech

ArciTech Set Zarge, Höhe 126 mm



Nennlänge mm	Artikelbeschreibung	Bestell-Nr. / Farbe / EAN / Preis			ME	VPE	Kat. / Seite
		weiß		€ / 100*			
270	Stahl pulverbeschichtet	9149270	4023149503863	1.764,22	ST	1	T&A 276
300	Stahl pulverbeschichtet	9149272	4023149503870	1.774,98	ST	1	T&A 276
350	Stahl pulverbeschichtet	9149273	4023149503887	1.792,93	ST	1	T&A 276
400	Stahl pulverbeschichtet	9149274	4023149503894	1.810,86	ST	1	T&A 276
450	Stahl pulverbeschichtet	9149275	4023149503900	1.828,80	ST	1	T&A 276
500	Stahl pulverbeschichtet	9149276	4023149503917	1.846,74	ST	1	T&A 276
550	Stahl pulverbeschichtet	9149277	4023149503924	1.864,68	ST	1	T&A 276
650	Stahl pulverbeschichtet	9149278	4023149503931	1.900,57	ST	1	T&A 276

ArciTech Set Rückwandverbinder, Höhe 94 mm



Artikelbeschreibung	Bestell-Nr. / Farbe / EAN / Preis			ME	VPE	Kat. / Seite
	weiß		€ / 100*			
für Holz oder Aluminium	9149280	4023149503597	493,38	ST	1	T&A 276

ArciTech Aluminiumrückwand, Höhe 126 mm



Artikelbeschreibung	Bestell-Nr. / Farbe / EAN / Preis			ME	VPE	Kat. / Seite
	weiß		€ / 100*			
Länge 2000 mm	9192196	4023149966705	6.147,83	ST	1	T&A 314

ArciTech Aluminiumfront



Artikelbeschreibung	Bestell-Nr. / Farbe / EAN / Preis			ME	VPE	Kat. / Seite
	weiß		€ / 100*			
Länge 2000 mm	9192206	4023149968303	3.468,63	ST	1	T&A 306

ArciTech Verbinder für Front, Höhe 126 mm



Artikelbeschreibung	Bestell-Nr. / Farbe / EAN / Preis			ME	VPE	Kat. / Seite
	weiß		€ / 100*			
Links / rechts	9123087	4023149037559	1.225,99	ST	1	T&A 306

ArciTech Set Rückwandverbinder, Höhe 186 mm



Artikelbeschreibung	Bestell-Nr. / Farbe / EAN / Preis			ME	VPE	Kat. / Seite
	weiß		€ / 100*			
für Holz oder Aluminium	9149281	4023149503603	627,94	ST	1	T&A 278

ArciTech Stahlrückwand, Höhe 186 mm



Artikelbeschreibung	Bestell-Nr. / Farbe / EAN / Preis			ME	VPE	Kat. / Seite
	weiß		€ / 100*			
Korpusbreite 600 mm	9121544	4023149048920	605,89	ST	1	.

Doppelwandiges Schubkastensystem ArciTech

ArciTech Aluminiumrückwand, Höhe 186 mm



Artikelbeschreibung	Bestell-Nr. / Farbe / EAN / Preis			ME	VPE	Kat. / Seite
	weiß	€ / 100*				
Länge 2000 mm	9192191	4023149965944	7.583,12	ST	1	T&A 314

ArciTech Aluminiumfront



Artikelbeschreibung	Bestell-Nr. / Farbe / EAN / Preis			ME	VPE	Kat. / Seite
	weiß	€ / 100*				
Länge 2000 mm	9192206	4023149968303	3.468,63	ST	1	T&A 306

Reling für Aluminiumfront



Artikelbeschreibung	Bestell-Nr. / Farbe / EAN / Preis			ME	VPE	Kat. / Seite
	weiß	€ / 100*				
Nennlänge 2000 mm	9182714	4023149855573	1.047,69	ST	1	T&A 306

ArciTech Verbinder für Front, Höhe 186 mm



Artikelbeschreibung	Bestell-Nr. / Farbe / EAN / Preis			ME	VPE	Kat. / Seite
	weiß	€ / 100*				
Links / rechts	9123090	4023149037566	1.734,31	ST	1	T&A 306

ArciTech Set Rückwandverbinder, Höhe 218 mm



Artikelbeschreibung	Bestell-Nr. / Farbe / EAN / Preis			ME	VPE	Kat. / Seite
	weiß	€ / 100*				
für Holz oder Aluminium	9149282	4023149503610	723,62	ST	1	T&A 282

ArciTech Aluminiumrückwand, Höhe 218 mm



Artikelbeschreibung	Bestell-Nr. / Farbe / EAN / Preis			ME	VPE	Kat. / Seite
	weiß	€ / 100*				
Länge 2000 mm	9192184	4023149965852	8.348,63	ST	1	T&A 314

ArciTech Set Längsreling



Nennlänge mm	Artikelbeschreibung	Bestell-Nr. / Farbe / EAN / Preis			ME	VPE	Kat. / Seite
		weiß	€ / 100*				
270	Stahl pulverbeschichtet	9149285	4023149503948	655,58	ST	1	T&A 278
300	Stahl pulverbeschichtet	9149286	4023149503955	664,55	ST	1	T&A 278
350	Stahl pulverbeschichtet	9149287	4023149503962	679,49	ST	1	T&A 278
400	Stahl pulverbeschichtet	9149288	4023149503979	694,45	ST	1	T&A 278
450	Stahl pulverbeschichtet	9149289	4023149503986	709,40	ST	1	T&A 278
500	Stahl pulverbeschichtet	9149290	4023149503993	724,35	ST	1	T&A 278
550	Stahl pulverbeschichtet	9149291	4023149504006	739,30	ST	1	T&A 278
650	Stahl pulverbeschichtet	9149292	4023149506291	769,20	ST	1	T&A 278

Frontbefestigung zum Anschrauben für Längsreling



Artikelbeschreibung	Bestell-Nr. / Farbe / EAN / Preis			ME	VPE	Kat. / Seite
	anthrazit	€ / 100*				
Kunststoff	9127011	4023149036965	11,96	ST	1	T&A 314

Unverbindliche Preisempfehlung. Preise gültig bei Abnahme von ganzen Verpackungseinheiten zzgl. MwSt.

Doppelwandiges Schubkastensystem ArciTech

ArciTech TopSide, Höhe 92 mm



Artikelbeschreibung	Bestell-Nr. / Farbe / EAN / Preis			ME	VPE	Kat. / Seite
	weiß	€ / 100*				
Nennlänge 500 mm	9122922	4023149049699	2.249,69	ST	1	T&A 278

ArciTech DesignSide Glas, Höhe 92 mm



Artikelbeschreibung	Bestell-Nr. / EAN / Preis			ME	VPE	Kat. / Seite
		€ / 100*				
Nennlänge 500 mm	9122988	4023149034954	1.717,06	GN	1	T&A 278

ArciTech DesignSide Adapter, Höhe 92 mm



Artikelbeschreibung	Bestell-Nr. / Farbe / EAN / Preis			ME	VPE	Kat. / Seite
	weiß	€ / 100*				
Nennlänge 500 mm	9122975	4023149034886	1.196,08	ST	1	T&A 278

ArciTech TopSide, Höhe 124 mm



Artikelbeschreibung	Bestell-Nr. / Farbe / EAN / Preis			ME	VPE	Kat. / Seite
	weiß	€ / 100*				
Nennlänge 500 mm	9122959	4023149049743	2.646,79	ST	1	T&A 282

ArciTech DesignSide Glas, Höhe 124 mm



Artikelbeschreibung	Bestell-Nr. / EAN / Preis			ME	VPE	Kat. / Seite
		€ / 100*				
Nennlänge 500 mm	9122996	4023149035890	2.252,91	GN	1	T&A 282

ArciTech DesignSide Adapter, Höhe 124 mm



Artikelbeschreibung	Bestell-Nr. / EAN / Preis			ME	VPE	Kat. / Seite
		€ / 100*				
weiß	9122980	4023149034893	1.794,11	ST	1	T&A 282

ArciTech Frontstabilisator



Artikelbeschreibung	Bestell-Nr. / EAN / Preis			ME	VPE	Kat. / Seite
		€ / 100*				
ab Korpusbreite 600 mm	9123080	4023149036934	77,75	ST	1	T&A 258

Frontbefestigung zum Anschrauben für Zarge

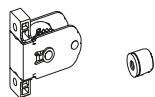

Artikelbeschreibung	Bestell-Nr. / Farbe / EAN / Preis			ME	VPE	Kat. / Seite
	anthrazit	€ / 100*				
Kunststoff	9123011	4023149036927	104,66	ST	1	T&A 314

Doppelwandiges Schubkastensystem ArciTech

OrgaTray 440



Breite mm	Tiefe mm	Bestell-Nr. / EAN / Farbe / Preis			ME	VPE	Kat. / Seite
		weiß		€ / 100*			
401 - 450	441 - 520	9194966	4023149747458	1.241,31	ST	1	T&A 318
451 - 500	441 - 520	9194967	4023149747519	1.310,72	ST	1	T&A 318
501 - 600	441 - 520	9194968	4023149747663	1.449,53	ST	1	T&A 318
701 - 800	441 - 520	9194970	4023149747977	2.728,22	ST	1	T&A 318

OrgaStripe Profil



Artikelbeschreibung	Bestell-Nr. / EAN / Preis			ME	VPE	Kat. / Seite
			€ / 100*			
weiß	9203465	4023149517167	337,28	ST	1	T&A 323

OrgaClip



Artikelbeschreibung	Bestell-Nr. / EAN / Preis			ME	VPE	Kat. / Seite
			€ / 100*			
weiß	9203468	4023149960000	77,57	ST	1	T&A 323

Doppelwandiges Schubkastensystem ArciTech

► Auszugsführung Actro

Actro mit Silent System, Belastbarkeit XS (10 kg)



Nennlänge mm	Artikelbeschreibung	Bestell-Nr. / EAN / Preis			ME	VPE	Kat. / Seite
				€/ 100*			
270	Korpusdicke 19 mm	9240920	4023149113017	2.047,69	ST	1	T&A 302
300	Korpusdicke 19 mm	9240922	4023149113024	2.069,21	ST	1	T&A 302
350	Korpusdicke 19 mm	9240923	4023149113031	2.105,10	ST	1	T&A 302

Actro mit Silent System, Belastbarkeit L (40 kg)



Nennlänge mm	Artikelbeschreibung	Bestell-Nr. / EAN / Preis			ME	VPE	Kat. / Seite
				€/ 100*			
270	Korpusdicke 19 mm	9240924	4023149113048	2.047,69	ST	1	T&A 302
300	Korpusdicke 19 mm	9240925	4023149113185	2.069,21	ST	1	T&A 302
350	Korpusdicke 19 mm	9240927	4023149113192	2.105,10	ST	1	T&A 302
400	Korpusdicke 19 mm	9240929	4023149113208	2.140,97	ST	1	T&A 302
450	Korpusdicke 19 mm	9240930	4023149113215	2.176,86	ST	1	T&A 302
500	Korpusdicke 19 mm	9240931	4023149113222	2.212,75	ST	1	T&A 302
550	Korpusdicke 19 mm	9240932	4023149113239	2.248,63	ST	1	T&A 302
650	Korpusdicke 19 mm	9240933	4023149113246	2.320,38	ST	1	T&A 302

Actro mit Silent System, Belastbarkeit XL (70 kg)



Nennlänge mm	Artikelbeschreibung	Bestell-Nr. / EAN / Preis			ME	VPE	Kat. / Seite
				€/ 100*			
450	Korpusdicke 19 mm	9240935	4023149113260	2.296,47	ST	1	T&A 302
500	Korpusdicke 19 mm	9240936	4023149113277	2.332,35	ST	1	T&A 302
550	Korpusdicke 19 mm	9240937	4023149113284	2.368,24	ST	1	T&A 302
650	Korpusdicke 19 mm	9240938	4023149113291	2.439,98	ST	1	T&A 302

Actro mit Silent System, Belastbarkeit XS (10 kg)



Nennlänge mm	Artikelbeschreibung	Bestell-Nr. / EAN / Preis			ME	VPE	Kat. / Seite
				€/ 100*			
270	Korpusdicke 18 mm	9240884	4023149150944	2.047,69	ST	1	T&A 302
300	Korpusdicke 18 mm	9240885	4023149112508	2.069,21	ST	1	T&A 302
350	Korpusdicke 18 mm	9240886	4023149112515	2.105,10	ST	1	T&A 302

Actro mit Silent System, Belastbarkeit L (40 kg)



Nennlänge mm	Artikelbeschreibung	Bestell-Nr. / EAN / Preis			ME	VPE	Kat. / Seite
				€/ 100*			
270	Korpusdicke 18 mm	9240887	4023149112522	2.047,69	ST	1	T&A 302
300	Korpusdicke 18 mm	9240888	4023149112539	2.069,21	ST	1	T&A 302
350	Korpusdicke 18 mm	9240889	4023149112546	2.105,10	ST	1	T&A 302
400	Korpusdicke 18 mm	9240890	4023149112553	2.140,97	ST	1	T&A 302
450	Korpusdicke 18 mm	9240891	4023149112560	2.176,86	ST	1	T&A 302
500	Korpusdicke 18 mm	9240893	4023149112577	2.212,75	ST	1	T&A 302
550	Korpusdicke 18 mm	9240894	4023149112638	2.248,63	ST	1	T&A 302
650	Korpusdicke 18 mm	9240895	4023149112645	2.320,38	ST	1	T&A 302

Doppelwandiges Schubkastensystem ArciTech

► Zubehör

Actro mit Silent System, Belastbarkeit XL (70 kg)



Nennlänge mm	Artikelbeschreibung	Bestell-Nr. / EAN / Preis			ME	VPE	Kat. / Seite
				€ / 100*			
450	Korpusdicke 18 mm	9240897	4023149112683	2.296,47	ST	1	T&A 302
500	Korpusdicke 18 mm	9240898	4023149112690	2.332,35	ST	1	T&A 302
550	Korpusdicke 18 mm	9240899	4023149112775	2.368,24	ST	1	T&A 302
650	Korpusdicke 18 mm	9240900	4023149112829	2.439,98	ST	1	T&A 302

Öffnungssystem Push to open Silent für ArciTech



Nennlänge mm	Artikelbeschreibung	Bestell-Nr. / EAN / Preis			ME	VPE	Kat. / Seite
				€ / 100*			
270 - 350	für Actro 10 kg	9241038	4023149078446	1.682,08	ST	1	T&A 304
270 - 650	für Actro 40 kg (Gewicht bis 20 kg)	9241049	4023149113543	1.682,08	ST	1	T&A 304
270 - 650	für Actro 40 kg (Gewicht bis 40 kg)	9241050	4023149113550	1.682,08	ST	1	T&A 304
400 - 650	für Actro 70 kg (Gewicht bis 70 kg)	9241051	4023149113567	1.682,08	ST	1	T&A 304

Synchronisationsstange für ArciTech Actro mit Push to open Silent



Artikelbeschreibung	Bestell-Nr. / EAN / Preis			ME	VPE	Kat. / Seite
			€ / 100*			
Länge 2000 mm	9236718	4023149089336	628,74	ST	1	T&A 263

Verbinder



Artikelbeschreibung	Bestell-Nr. / EAN / Preis			ME	VPE	Kat. / Seite
			€ / 100*			
Für Synchronisationsstange Push to open / Push to open Silent	9221295	4023149064234	56,96	ST	1	T&A 263

Distanzleiste



Artikelbeschreibung	Bestell-Nr. / EAN / Preis			ME	VPE	Kat. / Seite
			€ / 100*			
Für Auszugsführungen Actro und Kugelauszug KA 4532, Kunststoff weiß	9135703	4023149376009	618,46	ST	1	T&A 859

ArciTech Pull Rahmen



Artikelbeschreibung	Bestell-Nr. / EAN / Preis			ME	VPE	Kat. / Seite
			€ / 100*			
Nennlänge 500 mm / Korpusbreite 600 mm	9279404	4023149225260	19.041,90	ST	1	T&A 886

Eimer



Artikelbeschreibung	Bestell-Nr. / EAN / Preis			ME	VPE	Kat. / Seite
			€ / 100*			
8 l, anthrazit, 152 x 225 x 295 mm	9279390	4023149225123	1.027,48	ST	1	T&A 885
11 l, anthrazit, 152 x 304 x 295 mm	9279391	4023149225130	1.109,67	ST	1	T&A 885
17 l, anthrazit, 225 x 304 x 295 mm	9279392	4023149225147	1.150,77	ST	1	T&A 885
29 l, anthrazit, 225 x 304 x 460 mm	9279393	4023149225154	3.082,41	ST	1	T&A 885
42 l, anthrazit, 223 x 418 x 505 mm	9279394	4023149225161	6.404,02	ST	1	T&A 885

Unverbindliche Preisempfehlung. Preise gültig bei Abnahme von ganzen Verpackungseinheiten zzgl. MwSt.

Deckel



Artikelbeschreibung	Bestell-Nr. / EAN / Preis			ME	VPE	Kat. / Seite
			€ / 100*			
8 l, anthrazit, 152 x 225 x 21 mm	9279396	4023149225185	1.109,67	ST	1	T&A 885
11 l, anthrazit, 152 x 304 x 21 mm	9279397	4023149225192	1.571,07	ST	1	T&A 885
17 / 29 l, anthrazit, 225 x 304 x 21 mm	9279398	4023149225208	1.282,28	ST	1	T&A 885
40 l, anthrazit, 223 x 418 x 21 mm	9279399	4023149225215	2.942,56	ST	1	T&A 885

Fußpedal



Artikelbeschreibung	Bestell-Nr. / Oberfläche / EAN / Preis			ME	VPE	Kat. / Seite
	Edelstahl		€ / 100*			
Passend für ArciTech Pull, Edelstahl, Pull	9111679	4023149050718	5.667,56	ST	1	T&A 888

InsertFlex 600



Artikelbeschreibung	Bestell-Nr. / Oberfläche / EAN / Preis			ME	VPE	Kat. / Seite
	Edelstahl		€ / 100*			
für Schrankbreite 600 mm	9207642	4023149723872	19.957,51	ST	1	T&A 894

Auszugsführungen für Holzschubkästen

► Übersicht



Actro 5D mit Silent System und
Öffnungssystem Push to open Silent

62



Quadro 4D mit Silent System und
Öffnungssystem Push to open Silent
Quadro 4D V6 mit Push to open und
Synchronisation

65



Quadro V6 mit Silent System, EB 20,
Zubehör, Tablarbodenarretierung

68



Quadro 40 für Bodenmontage
Quadro V6 für Bodenmontage mit
Silent System

70



Kugelauszug KA 1730

71



Kugelauszug KA 270

71



Kugelauszug KA 290

71



Kugelauszug KA 4532

72



Kugelauszug KA 5632
Kugelauszug KA 4932

72, 73



Kugelauszug KA 4620

73



Rollenführung FR 402

74





Rollenführung FR 6142

74

Unverbindliche Preisempfehlung. Preise gültig bei Abnahme von ganzen Verpackungseinheiten zzgl. MwSt.

Auszugsführungen für Holzschubkästen

► Actro 5D

	Kat-Nr	Händler/EAN	Artikelbeschreibung	ME	VPE	€/ 100*	Katalog / Seite
Actro 5D mit Silent System, XS (10 kg)							
	9257054	4023149984129	Nennlänge 250 mm, links / rechts	GN	1	2.054,54	T&A 354
	9257055	4023149984211	Nennlänge 270 mm, links / rechts	GN	1	2.054,54	T&A 354
	9257056	4023149984594	Nennlänge 300 mm, links / rechts	GN	1	2.057,36	T&A 354
	9257057	4023149984709	Nennlänge 320 mm, links / rechts	GN	1	2.057,36	T&A 354
	9257058	4023149984990	Nennlänge 350 mm, links / rechts	GN	1	2.057,36	T&A 354
	Actro 5D mit Silent System, L (40 kg)						
	9257085	4023149995507	Nennlänge 250 mm, links / rechts	GN	1	2.054,54	T&A 354
	9257086	4023149995903	Nennlänge 270 mm, links / rechts	GN	1	2.054,54	T&A 354
	9257087	4023149995958	Nennlänge 300 mm, links / rechts	GN	1	2.057,36	T&A 354
	9257088	4023149996108	Nennlänge 320 mm, links / rechts	GN	1	2.057,36	T&A 354
	9257089	4023149997105	Nennlänge 350 mm, links / rechts	GN	1	2.057,36	T&A 354
	9257090	4023149997617	Nennlänge 380 mm, links / rechts	GN	1	2.076,13	T&A 354
	9257091	4023149998485	Nennlänge 400 mm, links / rechts	GN	1	2.076,13	T&A 354
	9257092	4023149804847	Nennlänge 420 mm, links / rechts	GN	1	2.094,91	T&A 354
	9257093	4023149807183	Nennlänge 450 mm, links / rechts	GN	1	2.094,91	T&A 354
	9257094	4023149808098	Nennlänge 480 mm, links / rechts	GN	1	2.113,69	T&A 354
	9257095	4023149808272	Nennlänge 500 mm, links / rechts	GN	1	2.113,69	T&A 354
	9257096	4023149809569	Nennlänge 520 mm, links / rechts	GN	1	2.226,35	T&A 354

Auszugsführungen für Holzschubkästen

► Actro 5D

Kat-Nr	Händler/EAN	Artikelbeschreibung	ME	VPE	€/ 100*	Katalog / Seite
9257097	4023149810398	Nennlänge 550 mm, links / rechts	GN	1	2.226,35	T&A 354
9268684	4023149191657	Nennlänge 600 mm, links / rechts	GN	1	2.451,68	T&A 354

Actro 5D mit Silent System, XL (70 kg)



9257121	4023149833281	Nennlänge 450 mm, links / rechts	GN	1	2.470,46	T&A 354
9257123	4023149838491	Nennlänge 500 mm, links / rechts	GN	1	2.489,23	T&A 354
9257124	4023149841965	Nennlänge 520 mm, links / rechts	GN	1	2.601,90	T&A 354
9257125	4023149842726	Nennlänge 550 mm, links / rechts	GN	1	2.601,90	T&A 354
9257126	4023149849770	Nennlänge 580 mm, links / rechts	GN	1	2.714,56	T&A 354
9257127	4023149852893	Nennlänge 600 mm, links / rechts	GN	1	2.827,23	T&A 354
9257128	4023149853869	Nennlänge 650 mm, links / rechts	GN	1	2.939,90	T&A 354
9257129	4023149854071	Nennlänge 700 mm, links / rechts	GN	1	3.165,22	T&A 354
9257130	4023149854156	Nennlänge 750 mm, links / rechts	GN	1	3.390,55	T&A 354

Actro 5D Schnäpper



9257268	4023149743153	Schnäpper links / rechts für Auszugsführung Actro 5 D 80 / 65 kg	GN	1	440,90	T&A 355
---------	---------------	--	----	---	--------	---------

Tiefenverstellung



9257706	4023149602498	links / rechts	ST	1	232,75	T&A 341
---------	---------------	----------------	----	---	--------	---------

Weitere Informationen finden Sie hier:
hettich.com/short/ba9fb5



Unverbindliche Preisempfehlung. Preise gültig bei Abnahme von ganzen Verpackungseinheiten zzgl. MwSt.

Auszugsführungen für Holzschubkästen

► Actro 5D

Kat-Nr	Händler/EAN	Artikelbeschreibung	ME	VPE	€ / 100*	Katalog / Seite
Öffnungssystem Push to open Silent für Actro 5D						
 9257890	4023149191473	Nennlänge 250 - 350 mm für Actro 5D, 10 kg	ST	1	1.928,00	T&A 262
9257891	4023149191534	Nennlänge 250 - 550 mm für Actro 5D, 40 kg (Gewicht 8 - 20 kg)	ST	1	1.928,00	T&A 262
9257892	4023149191480	Nennlänge 250 - 550 mm für Actro 5D, 40 kg (Gewicht 10 - 40 kg)	ST	1	1.928,00	T&A 262
9257893	4023149191497	Nennlänge 400 - 750 mm für Actro 5D, 60 / 80 kg (Gewicht 20 - 80 kg)	ST	1	1.928,00	T&A 262

Weitere Informationen finden Sie hier:
hettich.com/short/12f60c



Synchronisationsstange für Actro 5D mit Push to open Silent						
 9236718	4023149089336	Länge 2000 mm	ST	1	628,74	T&A 263

Actro 5 D Verbinder						
 9221295	4023149064234	Für Synchronisationsstange Push to open / Push to open Silent	ST	1	56,96	T&A 263

Optionale Multi-Synchronisation für Push to open Silent						
 9278452	4023149217869	Verbinder	ST	1	148,89	T&A 263

Auszugsführungen für Holzschubkästen

► Quadro 4D V6

	Kat-Nr	Händler/EAN	Artikelbeschreibung	ME	VPE	€/ 100*	Katalog / Seite
Quadro 4D V6 mit Silent System, 10 kg							
	9245377	4023149144233	Nennlänge 250 mm, links / rechts	ST	1	2.129,84	.
	9245378	4023149144240	Nennlänge 280 mm, links / rechts	ST	1	2.136,12	.
	9245379	4023149144257	Nennlänge 300 mm, links / rechts	ST	1	2.140,29	.
	9245380	4023149144264	Nennlänge 320 mm, links / rechts	ST	1	2.144,47	.
	9245381	4023149144271	Nennlänge 350 mm, links / rechts	ST	1	2.150,73	.
Quadro 4D V6 mit Silent System, 30 kg							
	9245382	4023149144288	Nennlänge 250 mm, links / rechts	ST	1	2.129,84	.
	9245383	4023149144295	Nennlänge 280 mm, links / rechts	ST	1	2.136,12	.
	9245384	4023149144301	Nennlänge 300 mm, links / rechts	ST	1	2.140,29	.
	9245385	4023149144318	Nennlänge 320 mm, links / rechts	ST	1	2.144,47	.
	9245386	4023149144325	Nennlänge 350 mm, links / rechts	ST	1	2.150,73	.
	9245387	4023149144332	Nennlänge 380 mm, links / rechts	ST	1	2.157,00	.
	9245388	4023149144349	Nennlänge 400 mm, links / rechts	ST	1	2.161,18	.
	9245389	4023149144356	Nennlänge 420 mm, links / rechts	ST	1	2.269,79	.
	9245390	4023149144363	Nennlänge 450 mm, links / rechts	ST	1	2.276,06	.
	9245391	4023149144370	Nennlänge 480 mm, links / rechts	ST	1	2.386,76	.
9245392	4023149144387	Nennlänge 500 mm, links / rechts	ST	1	2.390,94	.	
9245393	4023149144394	Nennlänge 520 mm, links / rechts	ST	1	2.499,55	.	

Unverbindliche Preisempfehlung. Preise gültig bei Abnahme von ganzen Verpackungseinheiten zzgl. MwSt.

Auszugsführungen für Holzschubkästen

► Quadro 4D V6

Kat-Nr	Händler/EAN	Artikelbeschreibung	ME	VPE	€/ 100*	Katalog / Seite
9245394	4023149144400	Nennlänge 550 mm, links / rechts	ST	1	2.505,81	.
9245395	4023149144417	Nennlänge 580 mm, links / rechts	ST	1	2.512,09	.
9245396	4023149144424	Nennlänge 600 mm, links / rechts	ST	1	2.516,26	.

Öffnungssystem Push to open Silent für Quadro 4D V6 mit Silent System



9246312	4023149146817	Nennlänge 250-350 mm, für Quadro 4D 10 kg	ST	1	1.989,27	.
9246315	4023149146824	Nennlänge 250-600 mm, für Quadro 4D 30 kg (Gewicht 8-20 kg)	ST	1	1.989,27	.
9246316	4023149146831	Nennlänge 350-600 mm, für Quadro 4D 30 kg (Gewicht 10-30 kg)	ST	1	1.989,27	.

Quadro 4D V6 mit Push to open



9247737	4023149193323	Nennlänge 250 mm, links / rechts	ST	1	2.599,81	.
9247738	4023149150296	Nennlänge 300 mm, links / rechts	ST	1	2.401,38	.
9247739	4023149150302	Nennlänge 320 mm, links / rechts	ST	1	2.405,56	.
9247740	4023149150319	Nennlänge 350 mm, links / rechts	ST	1	2.411,83	.
9247741	4023149150326	Nennlänge 380 mm, links / rechts	ST	1	2.418,09	.
9247742	4023149150333	Nennlänge 400 mm, links / rechts	ST	1	2.422,27	.
9247743	4023149150340	Nennlänge 420 mm, links / rechts	ST	1	2.426,45	.
9247744	4023149150357	Nennlänge 450 mm, links / rechts	ST	1	2.537,15	.
9247745	4023149150364	Nennlänge 480 mm, links / rechts	ST	1	2.543,42	.
9247746	4023149150371	Nennlänge 500 mm, links / rechts	ST	1	2.652,03	.
9247747	4023149150388	Nennlänge 520 mm, links / rechts	ST	1	2.656,21	.

Auszugsführungen für Holzschubkästen

► Quadro 4D V6

Kat-Nr	Händler/EAN	Artikelbeschreibung	ME	VPE	€/ 100*	Katalog / Seite
9247758	4023149150395	Nennlänge 550 mm, links / rechts	ST	1	2.871,35	.
9247759	4023149150401	Nennlänge 580 mm, links / rechts	ST	1	2.877,62	.
9248444	4023149150876	Nennlänge 600 mm, links / rechts	ST	1	2.881,79	.

Quadro 4D V6 Schnäpper



9247529	4023149150135	QV6 4D Schnäpper	ST	1	445,27	.
---------	---------------	------------------	----	---	--------	---

Synchronisationsstange für Quadro V6, 4D V6, V6+ mit Push to open



9236718	4023149089336	Länge 2000 mm	ST	1	628,74	T&A 263
---------	---------------	---------------	----	---	--------	---------

Adapter Typ A



9219966	4023149064203	Für Quadro V6, 4D V6, V6+ mit Push to open	ST	1	56,96	T&A 372
---------	---------------	--	----	---	-------	---------

Quadro V6 Push to open Verbinder



9221295	4023149064234	Für Synchronisationsstange Push to open	ST	1	56,96	T&A 263
---------	---------------	---	----	---	-------	---------

Push to open Multi-Synchronisation



9236526	4023149089275	Zweiseitiger Adapter Typ A	ST	1	68,34	T&A 372
---------	---------------	----------------------------	----	---	-------	---------

Unverbindliche Preisempfehlung. Preise gültig bei Abnahme von ganzen Verpackungseinheiten zzgl. MwSt.

Auszugsführungen für Holzschubkästen

► Quadro V6

	Kat-Nr	Händler/EAN	Artikelbeschreibung	ME	VPE	€/ 100*	Katalog / Seite
Quadro V6 mit Silent System, EB 20, 30 kg							
	9135983	4023149488078	Nennlänge 250 mm, links / rechts	GN	1	2.113,03	T&A 362
	0045284	4023149452840	Nennlänge 280 mm, links / rechts	GN	1	2.138,76	T&A 362
	0045285	4023149452857	Nennlänge 300 mm, links / rechts	GN	1	2.121,60	T&A 362
	0045286	4023149452864	Nennlänge 320 mm, links / rechts	GN	1	2.138,76	T&A 362
	0045287	4023149452871	Nennlänge 350 mm, links / rechts	GN	1	2.164,54	T&A 362
	0045288	4023149452888	Nennlänge 380 mm, links / rechts	GN	1	2.190,29	T&A 362
	0045289	4023149452895	Nennlänge 400 mm, links / rechts	GN	1	2.207,44	T&A 362
	0045290	4023149452901	Nennlänge 420 mm, links / rechts	GN	1	2.224,62	T&A 362
	0045291	4023149452918	Nennlänge 450 mm, links / rechts	GN	1	2.250,38	T&A 362
	0045292	4023149452925	Nennlänge 480 mm, links / rechts	GN	1	2.276,14	T&A 362
	0045293	4023149452932	Nennlänge 500 mm, links / rechts	GN	1	2.293,31	T&A 362
	0045294	4023149452949	Nennlänge 520 mm, links / rechts	GN	1	2.310,49	T&A 362
	0045295	4023149452956	Nennlänge 550 mm, links / rechts	GN	1	2.370,58	T&A 362
	0045296	4023149452963	Nennlänge 580 mm, links / rechts	GN	1	2.396,34	T&A 362
	0045297	4023149452970	Nennlänge 600 mm, links / rechts	GN	1	2.413,52	T&A 362

Auszugsführungen für Holzschubkästen





► Quadro V6

Kat-Nr	Händler/EAN	Artikelbeschreibung	ME	VPE	€/ 100*	Katalog / Seite
9117491	4023149343858	Nennlänge 250 mm, links / rechts	GN	1	2.044,34	T&A 362
9080224	4023149640957	Nennlänge 280 mm, links / rechts	GN	1	2.070,10	T&A 362
9080225	4023149140068	Nennlänge 300 mm, links / rechts	GN	1	2.052,91	T&A 362
9080226	4023149140075	Nennlänge 320 mm, links / rechts	GN	1	2.070,10	T&A 362
9080231	4023149140082	Nennlänge 350 mm, links / rechts	GN	1	2.095,84	T&A 362
9080232	4023149140099	Nennlänge 380 mm, links / rechts	GN	1	2.121,60	T&A 362
9080233	4023149140105	Nennlänge 400 mm, links / rechts	GN	1	2.138,76	T&A 362
9080234	4023149140112	Nennlänge 420 mm, links / rechts	GN	1	2.155,96	T&A 362
9080235	4023149140129	Nennlänge 450 mm, links / rechts	GN	1	2.181,69	T&A 362
9080236	4023149140136	Nennlänge 480 mm, links / rechts	GN	1	2.207,44	T&A 362
9080237	4023149140143	Nennlänge 500 mm, links / rechts	GN	1	2.224,62	T&A 362
9080238	4023149140150	Nennlänge 520 mm, links / rechts	GN	1	2.241,81	T&A 362
9080239	4023149140167	Nennlänge 550 mm, links / rechts	GN	1	2.301,91	T&A 362
9080240	4023149140174	Nennlänge 580 mm, links / rechts	GN	1	2.327,65	T&A 362
9080241	4023149140181	Nennlänge 600 mm, links / rechts	GN	1	2.310,49	T&A 362

Unverbindliche Preisempfehlung. Preise gültig bei Abnahme von ganzen Verpackungseinheiten zzgl. MwSt.

Auszugsführungen für Holzschubkästen

► Zubehör

	Kat-Nr	Händler/EAN	Artikelbeschreibung	ME	VPE	€ / 100*	Katalog / Seite
Schnäpper für Holzschubkästen mit genutetem Boden							
	9144830	4023149534089	Quadro 25 und Quadro V6, links	ST	1	64,30	T&A 363
	9144841	4023149534096	Quadro 25 und Quadro V6, rechts	ST	1	64,30	T&A 363
	9144597	4023149496189	Quadro 25 und Quadro V6, links / rechts	GN	1	136,24	T&A 363
Schnäpper für Tablarböden / Holzschubkästen ohne Blende mit bündigem Boden							
	0075808	4023149758089	Quadro 25 und Quadro V6	GN	1	136,24	T&A 363
Tablarbodenarretierung							
	9257725	4023149620492	weiß, links und rechts	ST	1	814,98	T&A 400
	9257727	4023149632495	anthrazit, links und rechts	ST	1	814,98	T&A 400
Quadro 40, für Bodenmontage, 40 kg							
	0066079	4023149660795	Schubkastenlänge 270 - 395 mm, links / rechts	GN	1	1.910,56	T&A 368
	0066075	4023149660757	Schubkastenlänge 330 - 490 mm, links / rechts	GN	1	2.096,30	T&A 368
	0066065	4023149660658	Schubkastenlänge 455 - 680 mm, links / rechts	GN	1	2.520,88	T&A 368
Quadro V6 BM mit Silent System, EB 20, 30 kg							
	9079486	4023149122316	Nennlänge 350 mm, links / rechts	GN	1	3.188,58	T&A 370
	9079523	4023149122392	Nennlänge 400 mm, links / rechts	GN	1	3.363,31	T&A 370
	9079437	4023149244315	Nennlänge 450 mm, links / rechts	GN	1	3.538,02	T&A 370
	9079454	4023149244339	Nennlänge 500 mm, links / rechts	GN	1	3.800,08	T&A 370

Auszugsführungen für Holzschubkästen

► Kugelauszüge

	Kat-Nr	Händler/EAN	Artikelbeschreibung	ME	VPE	€/ 100*	Katalog / Seite
Kugelauszug KA 1730, 17 mm Nut, 10 kg							
	0030765	4023149307652	Schubkastenlänge 185 - 305 mm	GN	1	268,86	T&A 380
	0066933	4023149669330	Schubkastenlänge 220 - 340 mm	GN	1	273,01	T&A 380
	0071835	4023149718359	Schubkastenlänge 220 - 355 mm	GN	1	281,23	T&A 380
	0071836	4023149718366	Schubkastenlänge 250 - 390 mm	GN	1	297,67	T&A 380
	0030766	4023149307669	Schubkastenlänge 250 - 410 mm	GN	1	318,28	T&A 380
	0079056	4023149790560	Schubkastenlänge 430 mm	GN	1	384,74	T&A 380
	0030767	4023149307676	Schubkastenlänge 450 mm	GN	1	373,84	T&A 380
Kugelauszug KA 270, 27 mm Nut, 12 kg							
	0025155	4023149251559	Schubkastenlänge 230 - 350 mm	GN	1	505,57	T&A 381
	0025156	4023149251566	Schubkastenlänge 350 - 550 mm	GN	1	956,99	T&A 381
Kugelauszug KA 290, 27 mm Nut, 20 kg							
	0026561	4023149265617	Schubkastenlänge 200 - 310 mm	GN	1	904,16	T&A 382
	0026562	4023149265624	Schubkastenlänge 310 - 450 mm	GN	1	977,47	T&A 382
	0026578	4023149265785	Schubkastenlänge 450 - 550 mm	GN	1	1.172,96	T&A 382

Unverbindliche Preisempfehlung. Preise gültig bei Abnahme von ganzen Verpackungseinheiten zzgl. MwSt.

Auszugsführungen für Holzschubkästen

► Kugelauszüge

	Kat-Nr	Händler/EAN	Artikelbeschreibung	ME	VPE	€ / 100*	Katalog / Seite
Kugelauszug KA 4532 Silent System, EB 12,7 mm, 35 kg							
	9114271	4023149601149	Schubkastenlänge 300 mm	GN	1	2.166,20	T&A 383
	9114273	4023149601156	Schubkastenlänge 350 mm	GN	1	2.382,81	T&A 383
	9114274	4023149601163	Schubkastenlänge 400 mm	GN	1	2.599,43	T&A 383
	9114275	4023149601187	Schubkastenlänge 450 mm	GN	1	2.816,06	T&A 383
	9114276	4023149601194	Schubkastenlänge 500 mm	GN	1	3.032,67	T&A 383
	9114277	4023149601217	Schubkastenlänge 550 mm	GN	1	3.303,44	T&A 383

	Kat-Nr	Händler/EAN	Artikelbeschreibung	ME	VPE	€ / 100*	Katalog / Seite
Kugelauszug KA 5632, EB 12,7 mm, 40 kg							
	0073276	4023149732768	Schubkastenlänge 250 mm	GN	1	891,38	T&A 385
	0073277	4023149732775	Schubkastenlänge 300 mm	GN	1	995,08	T&A 385
	0073278	4023149732782	Schubkastenlänge 350 mm	GN	1	1.106,76	T&A 385
	0073279	4023149732799	Schubkastenlänge 400 mm	GN	1	1.211,50	T&A 385
	0073280	4023149732805	Schubkastenlänge 450 mm	GN	1	1.321,50	T&A 385
	0073281	4023149732812	Schubkastenlänge 500 mm	GN	1	1.425,82	T&A 385
	0073282	4023149732829	Schubkastenlänge 550 mm	GN	1	1.550,52	T&A 385
	0073283	4023149732836	Schubkastenlänge 600 mm	GN	1	1.890,13	T&A 385
	0073284	4023149732843	Schubkastenlänge 650 mm	GN	1	1.984,87	T&A 385
	0041355	4023149413551	Schubkastenlänge 700 mm	GN	1	2.131,52	T&A 385

Auszugsführungen für Holzschubkästen

► Kugelauszüge

	Kat-Nr	Händler/EAN	Artikelbeschreibung	ME	VPE	€/ 100*	Katalog / Seite
Kugelauszug KA 4932, EB 12,7 mm, 60 kg							
	0041357	4023149413575	Schubkastenlänge 300 mm	GN	1	1.969,27	T&A 388
	0041358	4023149413582	Schubkastenlänge 350 mm	GN	1	2.166,20	T&A 388
	0041359	4023149413599	Schubkastenlänge 400 mm	GN	1	2.363,12	T&A 388
	0041361	4023149413612	Schubkastenlänge 450 mm	GN	1	2.560,05	T&A 388
	0041362	4023149413629	Schubkastenlänge 500 mm	GN	1	2.756,97	T&A 388
	0041363	4023149413636	Schubkastenlänge 550 mm	GN	1	3.003,13	T&A 388
	0041364	4023149413643	Schubkastenlänge 600 mm	GN	1	3.249,28	T&A 388
	0041366	4023149413667	Schubkastenlänge 700 mm	GN	1	3.790,84	T&A 388

	Kat-Nr	Händler/EAN	Artikelbeschreibung	ME	VPE	€/ 100*	Katalog / Seite
Kugelauszug KA 4620, EB 19 mm, 90 kg							
	0041394	4023149413940	Schubkastenlänge 500 mm	GN	1	4.004,92	T&A 389
	0041395	4023149413957	Schubkastenlänge 550 mm	GN	1	4.140,69	T&A 389
	0041396	4023149413964	Schubkastenlänge 600 mm	GN	1	4.480,08	T&A 389
	0041397	4023149413971	Schubkastenlänge 650 mm	GN	1	4.819,48	T&A 389
	0041398	4023149413988	Schubkastenlänge 700 mm	GN	1	5.226,76	T&A 389

Unverbindliche Preisempfehlung. Preise gültig bei Abnahme von ganzen Verpackungseinheiten zzgl. MwSt.

Auszugsführungen für Holzschubkästen

- ▶ Kugelauszug
- ▶ Rollenführung

	Kat-Nr	Händler/EAN	Artikelbeschreibung	ME	VPE	€ / 100*	Katalog / Seite
Kugelauszug KA 4532 AM Silent System, EB 12,7 mm, 35 kg							
	9114548	4023149601477	Schubkastenlänge 300 mm	GN	1	2.166,20	T&A 391
	9114553	4023149601484	Schubkastenlänge 350 mm	GN	1	2.382,81	T&A 391
	9114554	4023149601491	Schubkastenlänge 400 mm	GN	1	2.599,43	T&A 391
	9114555	4023149601507	Schubkastenlänge 450 mm	GN	1	2.816,06	T&A 391
	9114557	4023149601514	Schubkastenlänge 500 mm	GN	1	3.032,67	T&A 391
Rollenführung FR 402, 25 kg, weiß							
	1058345	4023149032042	Schubkastenlänge 350 mm	GN	1	342,68	T&A 397
	1058346	4023149032059	Schubkastenlänge 400 mm	GN	1	357,57	T&A 397
	1058347	4023149032066	Schubkastenlänge 450 mm	GN	1	372,46	T&A 397
	1058348	4023149032073	Schubkastenlänge 500 mm	GN	1	394,82	T&A 397
	1058349	4023149032080	Schubkastenlänge 550 mm	GN	1	424,62	T&A 397
	1058350	4023149032097	Schubkastenlänge 600 mm	GN	1	454,40	T&A 397
Rollenführung FR 6142, 50 kg							
	0041633	4023149416330	Schubkastenlänge 250 mm, weiß	GN	1	2.206,47	T&A 398
	0041635	4023149416354	Schubkastenlänge 300 mm, weiß	GN	1	2.251,17	T&A 398
	0041637	4023149416378	Schubkastenlänge 350 mm, weiß	GN	1	2.306,75	T&A 398
	0041639	4023149416392	Schubkastenlänge 400 mm, weiß	GN	1	2.407,06	T&A 398
	0041641	4023149416415	Schubkastenlänge 450 mm, weiß	GN	1	2.507,35	T&A 398

Auszugsführungen für Holzschubkästen

- ▶ Rollenführung
- ▶ Rückwandverbinder

Kat-Nr	Händler/EAN	Artikelbeschreibung	ME	VPE	€ / 100*	Katalog / Seite
0041643	4023149416439	Schubkastenlänge 500 mm, weiß	GN	1	2.657,78	T&A 398
0041645	4023149416453	Schubkastenlänge 550 mm, weiß	GN	1	2.858,39	T&A 398
0041647	4023149416477	Schubkastenlänge 600 mm, weiß	GN	1	3.058,98	T&A 398
0041649	4023149416491	Schubkastenlänge 650 mm, weiß	GN	1	3.309,70	T&A 398
0041651	4023149416514	Schubkastenlänge 700 mm, weiß	GN	1	3.560,45	T&A 398
0041653	4023149416538	Schubkastenlänge 750 mm, weiß	GN	1	3.861,33	T&A 398
0041655	4023149416552	Schubkastenlänge 800 mm, weiß	GN	1	4.162,20	T&A 398

Rückwandverbinder RV 8



0079438	4023149794384	Zur Fixierung von Schubkästenböden und Rückwänden, Kunststoff weiß	ST	1	13,07	T&A 400
---------	---------------	--	----	---	-------	---------

Distanzleiste



0013952	4023149139529	Passend für Auszugsführungen Quadro und Rollenführungen FR B 25 mm, T 484 mm, H 19 mm	ST	1	1.234,86	T&A 401
---------	---------------	---	----	---	----------	---------

Direktbefestigungsschraube



0051264	4023149512643	Flacher Senkknopf, PZ-Kreuzschlitz, Stahl verzinkt ø 6,3 x 10,5	ST	1	6,70	T&A 772
---------	---------------	---	----	---	------	---------

Unverbindliche Preisempfehlung. Preise gültig bei Abnahme von ganzen Verpackungseinheiten zzgl. MwSt.

Schiebe- und Falttürsysteme

► Übersicht



Obenlaufendes Schiebetürsystem TopLine XL

78



Obenlaufendes Schiebetürsystem TopLine L / vor dem Oberboden

79



Obenlaufendes Schiebetürsystem SysLine S

81



Obenlaufendes Schiebetürsystem TopLine 110

81



Obenlaufendes Schiebetürsystem TopLine 1

82



Obenlaufendes Schiebetürsystem TopLine 25/27

83



Untenlaufendes Schiebetürsystem SlideLine M

83



Untenlaufendes Schiebetürsystem SlideLine 55 Plus
Untenlaufendes Schiebetürsystem SlideLine 56

84



Untenlaufendes Schiebetürsystem SlideLine 97

85



Falttürsystem WingLine L





87



Zubehör für Schiebe- und Falttürsysteme

89

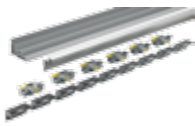
Unverbindliche Preisempfehlung. Preise gültig bei Abnahme von ganzen Verpackungseinheiten zzgl. MwSt.

	Kat-Nr	Händler/EAN	Artikelbeschreibung	ME	VPE	€/ 100*	Katalog / Seite
TopLine XL Lauf- und Führungsteile							
	9275796	4023149228384	Set 2-türig, 18 - 30 mm, 60 kg	ST	1	15.320,34	T&A 413
	9275794	4023149659584	Set 2-türig, 22 - 30 mm, 80 kg	ST	1	15.727,53	T&A 413
	9275786	4023149228346	Set 3-türig, 18 - 30 mm, 60 kg	ST	1	21.150,36	T&A 413
	9275785	4023149231681	Set 3-türig, 22 - 30 mm, 80 kg	ST	1	21.557,55	T&A 413
	9278780	4023149218347	Set 4-türig, 18 - 30 mm, 60 kg	ST	1	31.360,74	T&A 413
	9278791	4023149218354	Set 4-türig, 22 - 30 mm, 80 kg	ST	1	32.194,25	T&A 413
	TopLine XL Dämpfung Silent System						
	9276735	4023149211836	Set 2-türig, 15 - 35 kg	ST	1	7.050,00	T&A 413
	9276732	4023149211829	Set 2-türig, 30 - 80 kg	ST	1	7.050,00	T&A 413
	9276645	4023149211744	Set 3-türig, 15 - 35 kg	ST	1	14.175,00	T&A 413
	9276643	4023149211720	Set 3-türig, 30 - 80 kg	ST	1	14.175,00	T&A 413
	9278798	4023149218422	Set 4-türig, 15 - 35 kg	ST	1	20.100,00	T&A 413
	9278799	4023149218439	Set 4-türig, 30 - 80 kg	ST	1	20.100,00	T&A 413
	TopLine XL Lauf- und Führungsprofile						
	9278657	4023149218224	Set 4.000 mm	ST	1	22.304,36	T&A 413
	9278672	4023149234941	Set 2.300 mm	ST	1	12.825,00	T&A 413
TopLine XL Systemzubehör							
	9278801	4023149218453	Abdeckprofil grau, 2.000 mm	ST	1	1.800,00	T&A 414

Weitere Informationen finden Sie hier:
hettich.com/short/69f314





Schiebe- und Falttürsysteme

► TopLine L

	Kat-Nr	Händler/EAN	Artikelbeschreibung	ME	VPE	€/ 100*	Katalog / Seite
TopLine L Lauf- und Führungsteile							
	9242711	4023149228926	Set 2-türig, links, 18 - 30 mm, 50 kg	ST	1	7.136,27	T&A 421
	9242712	4023149228933	Set 2-türig, rechts, 18 - 30 mm, 50 kg	ST	1	7.136,27	T&A 421
	9242713	4023149229077	Set 3-türig, 18 - 30 mm, 50 kg	ST	1	9.717,08	T&A 421

	Kat-Nr	Händler/EAN	Artikelbeschreibung	ME	VPE	€/ 100*	Katalog / Seite
TopLine L Dämpfung Silent System							
	9242238	4023149142451	Set 2-türig, 50 kg	ST	1	4.407,06	T&A 421
	9242240	4023149142475	Set 3-türig, 50 kg	ST	1	8.216,78	T&A 421
	9277096	4023149254871	Set 2-türig, 20 kg	ST	1	4.407,06	T&A 421
	9277098	4023149212369	Set 3-türig, 20 kg	ST	1	8.216,78	T&A 421

	Kat-Nr	Händler/EAN	Artikelbeschreibung	ME	VPE	€/ 100*	Katalog / Seite
TopLine L Lauf- und Führungsprofile							
	9277164	4023149212550	Set 2.300 mm	ST	1	7.601,73	T&A 421
	9277167	4023149212581	Set 4.000 mm	ST	1	12.811,89	T&A 421

	Kat-Nr	Händler/EAN	Artikelbeschreibung	ME	VPE	€/ 100*	Katalog / Seite
TopLine L Systemzubehör							
	9277440	4023149212840	Abdeckprofil grau, 1.000 mm	ST	1	543,48	T&A 422

	Kat-Nr	Händler/EAN	Artikelbeschreibung	ME	VPE	€/ 100*	Katalog / Seite
TopLine L Befestigungslaschen							
	9277155	4023149212413	Set halbes Bohrbild	ST	1	207,80	T&A 422
	9277156	4023149212420	Set vollständiges Bohrbild	ST	1	376,68	T&A 422

Weitere Informationen finden Sie hier:
hettich.com/short/9c876e









Unverbindliche Preisempfehlung. Preise gültig bei Abnahme von ganzen Verpackungseinheiten zzgl. MwSt.

	Kat-Nr	Händler/EAN	Artikelbeschreibung	ME	VPE	€ / 100*	Katalog / Seite
TopLine L Profilbefestigung							
	9130078	4023149980541	Bodendicke 16 - 19 mm	ST	1	224,67	T&A 422
	9180317	4023149984181	Bodendicke 20 - 22 mm	ST	1	224,67	T&A 422
	9180318	4023149965357	Bodendicke 22 - 25 mm	ST	1	224,67	T&A 422

Schiebe- und Falttürsysteme





- ▶ SysLine S, Zubehör
- ▶ TopLine 110, Zubehör

	Kat-Nr	Händler/EAN	Artikelbeschreibung	ME	VPE	€ / 100*	Katalog / Seite
SysLine S Set mit Silent System Schließdämpfung und Öffnungsdämpfung							
	9208511	4023149911842	Für einen 2-türigen Schrank	ST	1	12.080,01	T&A 463
SysLine S Set mit Silent System Schließdämpfung							
	9134311	4023149070242	Für einen 2-türigen Schrank	ST	1	10.003,74	T&A 463
SysLine S Set ohne Silent System							
	9136103	4023149066719	Für einen 2-türigen Schrank	ST	1	5.568,13	T&A 463
Laufprofil zum Anschrauben SysLine S							
	9136105	4023149066733	Länge 2000 mm, Aluminium blank	ST	1	2.385,90	T&A 463
Set TopLine 110							
	0045317	4023149453175	Für einen 2-türigen Schrank	GN	1	4.785,86	T&A 471
Laufprofil TopLine 110							
	9040230	4023149453182	Länge 3000 mm, Aluminium eloxiert	ST	1	2.343,83	T&A 471
Silent System für SL 55/SL 56/TL 110/TL 112							
	9079731	4023149123375	Set für SL 55 / SL 56 / TL 110 / TL 112	ST	1	5.411,57	T&A 471

Unverbindliche Preisempfehlung. Preise gültig bei Abnahme von ganzen Verpackungseinheiten zzgl. MwSt.

Schiebe- und Falttürsysteme









- ▶ TopLine 1, Zubehör
- ▶ TopLine 25, Zubehör

	Kat-Nr	Händler/EAN	Artikelbeschreibung	ME	VPE	€ / 100*	Katalog / Seite
TopLine 1 Komp.-Set, 2-/3-türig							
	0045076	4023149450761	2-türig, 50 kg	GN	1	7.298,33	T&A 487
	0045077	4023149450778	3-türig, 50 kg	GN	1	10.339,29	T&A 487
	0045078	4023149450785	2-türig, 75 kg	GN	1	12.772,07	T&A 487
	0045079	4023149450792	3-türig, 75 kg	GN	1	17.029,42	T&A 487
Laufprofil TopLine 1							
	0071113	4023149711138	Länge 3000 mm, silber, Aluminium blank	ST	1	8.227,71	T&A 487
	0045097	4023149450976	Länge 6000 mm, silber, Aluminium blank	ST	1	16.455,42	T&A 487
Höhenverstellbares Befestigungselement für Laufteil							
	0023994	4023149239946	Befestigungselement für Laufteil TopLine 1	ST	1	454,08	T&A 487
Führung STB 11							
	0045080	4023149450808	Set Führung STB 11, 2-türig	GN	1	2.123,43	T&A 464
	0045081	4023149450815	Set Führung STB 11, 3-türig	GN	1	2.567,00	T&A 464
	0071117	4023149711176	Führungsprofil STB 11, 3000 mm, Aluminium	ST	1	5.368,04	T&A 464
	0046419	4023149464195	Führungsprofil STB 11, 6000 mm, Aluminium	ST	1	10.733,48	T&A 464
TopLine 25 Komp.-Set							
	0026081	4023149260810	1-türig	GN	1	1.672,71	T&A 477
	0026082	4023149260827	2-türig	GN	1	2.991,46	T&A 477
	0026083	4023149260834	3-türig	GN	1	4.710,34	T&A 477

Schiebe- und Falttürsysteme

► TopLine 25/27, Zubehör

► SlideLine M, Zubehör







	Kat-Nr	Händler/EAN	Artikelbeschreibung	ME	VPE	€/ 100*	Katalog / Seite
Laufprofil TopLine 25 für 1-türig							
	0046416	4023149464164	Länge 3500 mm, Aluminium blank	ST	1	3.105,43	T&A 477
Laufprofil TopLine 27 für 2- und 3-türig							
	0046417	4023149464171	Länge 3500 mm, Aluminium blank	ST	1	7.156,02	T&A 477
Beschlagset für gedämpfte Türen (Schließ-, Öffnungs- und Kollisionsdämpfung)							
	9201921	4023149913488	10 kg Türgewicht	ST	1	9.880,54	T&A 431
	9156338	4023149391668	30 kg Türgewicht	ST	1	9.880,54	T&A 431
Beschlagset für ungedämpfte Türen							
	9156339	4023149507670	30 kg Türgewicht	ST	1	7.252,56	T&A 431
SlideLine M Profilsets: 2 Profile							
	9209218	4023149966729	Profilhöhe 18 mm, 4000 mm, Aluminium silber	ST	1	8.575,09	T&A 431
Farbsets zur farblichen Abdeckung der Laufprofile SlideLine M, Profilhöhe 18 mm							
	9209278	4023149979811	Länge 4000 mm, silber	ST	1	1.789,32	T&A 432
	9209280	4023149980404	Länge 4000 mm, schwarz	ST	1	1.789,32	T&A 432
	9209283	4023149980602	Länge 4000 mm, weiß	ST	1	1.789,32	T&A 432
Profilset SL-M, 2-bahniges Laufprofil							
	9227245	4023149098512	2.500 mm, zum Anschrauben / Ankleben	ST	1	6.825,94	T&A 443
		9227246	4023149098529	2.500 mm, zum Einpressen	ST	1	5.363,17

Unverbindliche Preisempfehlung. Preise gültig bei Abnahme von ganzen Verpackungseinheiten zzgl. MwSt.

Schiebe- und Falttürsysteme

► SlideLine 55 Plus









► Zubehör

	Kat-Nr	Händler/EAN	Artikelbeschreibung	ME	VPE	€ / 100*	Katalog / Seite
Klebeband für 2-bahniges Laufprofil							
	9227006	4023149092718	Länge 25 m	ST	1	1.656,78	T&A 444
Befestigungsschrauben für 2-bahniges Laufprofil							
	9229240	4023149097959	für 16 mm	ST	1	165,67	T&A 444
	9229241	4023149097942	für 18 - 19 mm	ST	1	165,67	T&A 444
	9229243	4023149098536	für 25 mm	ST	1	165,67	T&A 444
SlideLine 55 Plus Laufteil							
	9115219	4023149188046	Zum Anschrauben für Schränke mit 2 einliegenden Türen, Kunststoff	ST	1	172,55	T&A 453
SlideLine 55 Plus Führungsteil							
	9115217	4023149188022	Zum Anschrauben für Schränke mit 2 einliegenden Türen, Kunststoff	ST	1	93,69	T&A 453
SlideLine 55 Plus Türanschlag / Abstandhalter							
	9115216	4023149188015	Zum Anschrauben	ST	1	50,78	T&A 455
SlideLine 55 Plus Zuhaltung							
	9115218	4023149188039	Kunststoff	ST	1	94,30	T&A 454
Lauf- und Führungsprofile STB 55							
	0025120	4023149251207	Länge 4000 mm, weiß, max. Türgewicht 15 kg	ST	1	424,44	T&A 454
	0025121	4023149251214	Länge 4000 mm, braun, max. Türgewicht 15 kg	ST	1	424,44	T&A 454
	0025660	4023149256608	Länge 4000 mm, beige, max. Türgewicht 15 kg	ST	1	424,44	T&A 454
	0061546	4023149615467	Länge 4000 mm, grau, max. Türgewicht 15 kg	ST	1	424,44	T&A 454
	0066900	4023149669002	Länge 4000 mm, schwarz, max. Türgewicht 15 kg	ST	1	424,44	T&A 454
	1079090	4023149033599	Länge 4000 mm, silber, max. Türgewicht 30 kg	ST	1	1.431,70	T&A 454
	0070961	4023149032028	Länge 4000 mm, dunkelbraun, max. Türgewicht 30 kg	ST	1	1.573,44	T&A 454





Schiebe- und Falttürsysteme

► SlideLine 56, Zubehör

► SlideLine 97, Zubehör

	Kat-Nr	Händler/EAN	Artikelbeschreibung	ME	VPE	€/ 100*	Katalog / Seite
Set SlideLine 56							
	0045234	4023149452345	Für Schrank mit 2 Türen	GN	1	2.883,61	T&A 497
	0045235	4023149452352	Für Schrank mit 3 Türen	GN	1	4.269,08	T&A 497
Dämpfungssystem Silent System							
	9079731	4023149123375	Silent System für SL 55 / SL / 56 / TL110 / TL112	ST	1	5.411,57	T&A 471
Lauf- und Führungsprofil SlideLine 56							
	0071110	4023149711107	Länge 3000 mm, Aluminium, silber eloxiert	ST	1	4.397,95	T&A 497
	0046788	4023149467882	Länge 6000 mm, Aluminium, silber eloxiert	ST	1	8.795,91	T&A 497
Doppel-Führungsprofil SlideLine 97							
	0076470	4023149764707	beflockt für Länge 5000 mm, Aluminium, silber eloxiert	ST	1	15.873,05	T&A 505
SlideLine 97 Einschubprofil							
	0076474	4023149764745	Länge 5000 mm für 6 mm Glasstärke	ST	1	2.040,52	T&A 503
SlideLine 97 Rahmenprofil							
	0076476	4023149764769	Aluminium, eloxiert	ST	1	10.742,70	T&A 505
SlideLine 97 Laufschuh							
	0076471	4023149764714	Aluminium, eloxiert, silber	ST	1	12.525,13	T&A 503
Laufwerk für SlideLine 97							
	0076472	4023149764721	Stahl-Kugellagerrolle	ST	1	828,79	T&A 503
Anschlagdämpfer und Aushängesicherung für SlideLine 97							
	0076475	4023149764752	Kunststoff	ST	1	275,74	T&A 505

Unverbindliche Preisempfehlung. Preise gültig bei Abnahme von ganzen Verpackungseinheiten zzgl. MwSt.

	Kat-Nr	Händler/EAN	Artikelbeschreibung	ME	VPE	€ / 100*	Katalog / Seite
Doppel-Laufschiene für SlideLine 97							
	0076478	4023149764783	Länge 5000 mm, Aluminium silber, eloxiert	ST	1	6.814,06	T&A 505
Endplatte für SlideLine 97							
	0076480	4023149764806	Bis 8 mm Glasdicke, Kunststoff verchromt	ST	1	295,79	T&A 504
Laufschuhgriff für SlideLine 97							
	0076481	4023149764813	Bis 8 mm Glasdicke, Kunststoff verchromt	ST	1	1.123,21	T&A 504
Zylinderdruckschloss							
	0076483	4023149764837	verchromt matt	ST	1	4.430,15	T&A 504
Adapter für Zylinderdruckschloss							
	0076482	4023149764820	verchromt matt	ST	1	1.729,68	T&A 504

Schiebe- und Falttürsysteme

► WingLine L, Zubehör

	Kat-Nr	Händler/EAN	Artikelbeschreibung	ME	VPE	€/ 100*	Katalog / Seite
WingLine L							
	9277991	4023149216381	Laufteilset mit unterer Führung, 12 kg, grau, links mit Schließautomatik	ST	1	2.898,42	T&A 538
	9278004	4023149216404	Laufteilset mit unterer Führung, 12 kg, grau, rechts mit Schließautomatik	ST	1	2.898,42	T&A 538
	9278485	4023149218019	Laufteilset mit unterer Führung, 25 kg, grau, links mit Schließautomatik	ST	1	3.290,70	T&A 538
	9278486	4023149218026	Laufteilset mit unterer Führung, 25 kg, grau, rechts mit Schließautomatik	ST	1	3.290,70	T&A 538
	9278260	4023149216909	Laufteilset mit unterer Führung, 12 kg, grau, links ohne Schließautomatik	ST	1	2.898,42	T&A 538
	9278285	4023149217616	Laufteilset mit unterer Führung, 12 kg, grau, rechts ohne Schließautomatik	ST	1	2.898,42	T&A 538
	9278571	4023149254901	Laufteilset mit unterer Führung, 25 kg, grau, links ohne Schließautomatik	ST	1	3.290,70	T&A 538
	9278580	4023149224515	Laufteilset mit unterer Führung, 25 kg, grau, rechts ohne Schließautomatik	ST	1	3.290,70	T&A 538

WingLine L Zubehör							
	9278694	4023149234958	Mittelscharnier zum Anschrauben, 2er Set	ST	1	2.558,41	T&A 539
	9278742	4023149218262	Mittelscharnier zum Anschrauben, 3er Set	ST	1	3.837,51	T&A 539

WingLine L Lauf- und Führungsprofile							
	9239311	4023149113536	Profilset 1200mm	ST	1	2.933,86	T&A 540
	9239310	4023149113659	Profilset 2400mm	ST	1	5.633,02	T&A 540

Weitere Informationen finden Sie hier:
hettich.com/short/41ad0f









	Kat-Nr	Händler/EAN	Artikelbeschreibung	ME	VPE	€ / 100*	Katalog / Seite
WingLine L Komforteinheiten							
	9266113	4023149239151	Basisset Push to move leicht, grau, links	ST	1	7.823,63	T&A 541
	9266111	4023149239168	Basisset Push to move leicht, grau, rechts	ST	1	7.823,63	T&A 541
	9265960	4023149255908	Basisset Push to move mittel, grau, links	ST	1	8.382,47	T&A 541
	9266112	4023149254864	Basisset Push to move mittel, grau, rechts	ST	1	8.382,47	T&A 541
	9265958	4023149257872	Basisset Push to move schwer, grau, links	ST	1	8.941,30	T&A 541
	9265959	4023149239359	Basisset Push to move schwer, grau, rechts	ST	1	8.941,30	T&A 541

WingLine L Zubehör							
	9264191	4023149182297	Set Mechanische Zuhaltung, grau	ST	1	1.673,70	T&A 541
	9266220	4023149186301	Set Magnetische Zuhaltung, grau	ST	1	1.826,95	T&A 541





WingLine L Komforteinheiten							
	9238120	4023149145803	Komplettsset Pull to move Silent leicht, links	ST	1	7.459,00	T&A 542
	9238119	4023149143755	Komplettsset Pull to move Silent leicht, rechts	ST	1	7.459,00	T&A 542
	9238121	4023149145810	Komplettsset Pull to move Silent mittel, links	ST	1	8.017,83	T&A 542
	9238124	4023149145827	Komplettsset Pull to move Silent mittel, rechts	ST	1	8.017,83	T&A 542
	9238123	4023149145834	Komplettsset Pull to move Silent schwer, links	ST	1	8.576,66	T&A 542
	9238122	4023149144554	Komplettsset Pull to move Silent schwer, rechts	ST	1	8.576,66	T&A 542

Schiebe- und Faltsürsysteme

► WingLine L, Zubehör

	Kat-Nr	Händler/EAN	Artikelbeschreibung	ME	VPE	€ / 100*	Katalog / Seite
Set WingLine 77							
	0070983	4023149709838	1 x Faltsüür mit 2 Flügeln, links	GN	1	6.681,58	T&A 575
	0070984	4023149709845	1 x Faltsüür mit 2 Flügeln, rechts	GN	1	6.681,58	T&A 575
WingLine 77 Laufprofil							
	9193573	4023149421235	Länge 2000 mm, Aluminium, silber eloxiert	ST	1	3.972,39	T&A 575
Zubehör WingLine L							
	0046787	4023149467875	Mittelscharnier, Öffnungswinkel 180°, für Faltsüüren, mit einstellbarem, versetztem Drehpunkt, zum Anschrauben	ST	1	1.279,10	T&A 163
	9073605	4023149696497	Sensys 8645i, Öffnungswinkel 110°, mit integrierter Dämpfung, Basis 12,5 mm, TH 52, zum Anschrauben	ST	1	302,57	T&A 26
	9073662	4023149256721	Sensys 8645, Öffnungswinkel 110°, ohne integrierte Dämpfung, Basis 12,5 mm, TH 52, zum Anschrauben	ST	1	239,96	T&A 26
	9075071	4023149127441	Kreuzmontageplatte mit Spreizmuffen und Spezialschrauben, für Sensys, mit Exzenter-Höhenverstellung, D = 1.5 mm, ø 5 x 12 mm	ST	1	67,28	T&A 63
	9088250	4023149182464	Abdeckkappe für Sensys Scharnierarm, geprägt mit Hettich Logo	ST	1	12,49	T&A 69
Türleiste							
	9136121	4023149066795	Türdicke 19 mm / 18 mm, Länge 2500 mm, Aluminium	ST	1	3.348,83	T&A 584
Ausrichtbeschlag							
	9252651	4023149155130	Aluminium	ST	1	3.002,82	T&A 414
	0045198	4023149127984	Kunststoff	ST	1	1.986,98	T&A 591
Griffadapter für Schiebe- / Faltschiebetüren							
	0115365	4023149393013	Verchromt matt	ST	1	294,84	T&A 587
	0115366	4023149393020	Vernickelt matt	ST	1	301,27	T&A 587

Unverbindliche Preisempfehlung. Preise gültig bei Abnahme von ganzen Verpackungseinheiten zzgl. MwSt.

	Kat-Nr	Händler/EAN	Artikelbeschreibung	ME	VPE	€ / 100*	Katalog / Seite
Sockelverstellerschraube mit Gewinde M8							
	0047637	4023149476372	Höhe 50 mm	ST	1	42,11	T&A 802
	0047638	4023149476389	Höhe 60 mm	ST	1	51,11	T&A 802
	0047639	4023149476396	Höhe 70 mm	ST	1	52,74	T&A 802
	0047640	4023149476402	Höhe 80 mm	ST	1	59,57	T&A 802
	0047642	4023149476426	Höhe 100 mm	ST	1	65,22	T&A 802
Einschlagmutter mit Gewinde M8							
	0047643	4023149476433	Stahl blank	ST	1	9,14	T&A 802
Halteplatte mit Gewinde M8							
	0047645	4023149476457	Stahl verzinkt	ST	1	24,12	T&A 802
Doppelwinkel mit Gewinde M8							
	0071870	4023149718700	Stahl verzinkt	ST	1	49,82	T&A 802



Exzenter-Verbindungsbeschlag Rastex 15, Schnellmontagedübel Rapid S, Einschraubdübel Twister und Stahldübel, Durchmesser 15 mm

94



Exzenter-Verbindungsbeschlag Rastex 25, Einschraubdübeln Twister, Durchmesser 25 mm

95



Exzenter-Verbindungsbeschlag VB 20 / 21

96



Exzenter-Verbindungsbeschlag VB 35 / 35 M / 36 / 36 M

97



Tablarverbinder VB 54 Toolux

98



Trapez-Verbindungsbeschlag TZ 4, TZ 4 STD

98



Verbinder mit Form- und Kraftschluss VB 25 T

98



Arbeitsplattenverbinder AVB 4, AVB 4 Slim, AVB 5

98



Einhängebeschlag MultiClip

99



Rückwandverbinder RV 1, RV 3, RV 7D, RV 8

99



Frontblendenverbinder VB 15, Verbindungsplatte

99



Eurowinkel, Universal-Eckverbinder, Universalwinkel, Linsenkopfbeschläge und Verbindungsschrauben Direkta 2, Verbindungsschraube VS, VHS 32

99



Endschrauben, Hülsen, Muffen, Schrauben, Abdeckkappen

101



Verbindungsbeschläge für Betten, Bettverbindungsbeschlag mit Haken, Winkelbettbeschlag, StabuloFix, VariFix, Stützfuß und Verbinder für Mittelbalken

102



Rastomat, MultiFlex, Springaufbeschlag, Klappenbeschlag SchwenkFix

102



Sockelverstellfuß Korrekt mit Gleitern, Sockelverstellwerkzeug, Zubehörartikel

103



Sockelversteller Systema Top 2000, Sockelverstellerschrauben, Bodenträger Vari Stahl

104



Bodenträger Safety, Sekura, Universal D, Universal K, Duplo, Steckboden-, Glasboden, Löffelboden-, Nutbodenträger, Fachbodensicherung

104



Regalbodenträger Titan 1 mit Seitenverstellung, Titan1, Titan 2, Titan 3, Regalbodenträger mit Neigungsausgleich

106







Schrankaufhänger SAH 215/216, SAH 130, SAH 15, SAH 116, SAH 305

106











Aufhängeschienen / Typ L / B, Befestigungsmaterial und Puffer

107







	Kat-Nr	Händler/EAN	Artikelbeschreibung	ME	VPE	€/ 100*	Katalog / Seite
Rastex 15 mit Abdeckrand							
	0071950	4023149719509	Plattendicke 19 mm, vernickelt	ST	1	11,64	T&A 730
	0073460	4023149734601	Plattendicke 19 mm, vernickelt	ST	1	11,09	T&A 730
Rastex 15 ohne Abdeckrand							
	0025062	4023149250620	Plattendicke 16 mm, vernickelt	ST	1	9,17	T&A 730
	0013957	4023149139574	Plattendicke 18 mm, vernickelt	ST	1	9,28	T&A 730
	0025064	4023149250644	Plattendicke 19 mm, vernickelt	ST	1	10,13	T&A 730
	0073457	4023149734571	Plattendicke 19 mm, vernickelt	ST	1	9,64	T&A 730
	0079471	4023149794711	Plattendicke 19 mm, blank	ST	1	9,23	T&A 730
	0079472	4023149794728	Plattendicke 19 mm, blank	ST	1	8,76	T&A 730
Abdeckkappen für Rastex 15 ohne Abdeckrand (außer Rastex 15/12)							
	0071054	4023149710544	weiß	ST	1	2,39	T&A 731
Schnellmontagedübel Rapid S							
	0044750	4023149447501	Rapid S DU 324, Spannmaß 20 mm	ST	1	8,82	T&A 733
	0047458	4023149474583	Rapid S DU 325, Spannmaß 30 mm	ST	1	9,16	T&A 733
Einschraubdübel Twister							
	0048037	4023149480379	Twister DU 319 T, Spannmaß 20 mm	ST	1	8,15	T&A 733
	0048038	4023149480386	Twister DU 320 T, Spannmaß 30 mm	ST	1	8,47	T&A 733
	0020056	4023149200564	Twister DU 243 T, Spannmaß 20 mm	ST	1	9,14	T&A 734
	0020058	4023149200588	Twister DU 232 T, Spannmaß 30 mm	ST	1	9,14	T&A 734

Verbindungstechnik

- ▶ Rastex
- ▶ Dübel

	Kat-Nr	Händler/EAN	Artikelbeschreibung	ME	VPE	€ / 100*	Katalog / Seite
Einschraubdübel Twister DU 644 T							
	0020157	4023149201578	Spannmaß 30 mm	ST	1	9,14	T&A 734
Einschraubdübel DU 425							
	0079521	4023149795213	Spannmaß 30 mm	ST	1	12,76	T&A 734
Doppeldübel DU 880							
	0079554	4023149795541	Spannmaß 59 mm	ST	1	44,11	T&A 735
Doppeldübel DU 853							
	0079568	4023149795688	Spannmaß 79 mm	ST	1	47,81	T&A 735
Gelenkdübel DU 860							
	0079580	4023149795800	Spannmaß 39 mm	ST	1	67,05	T&A 736
Gelenkdübel DU 634							
	9129712	4023149795718	Spannmaß 39 mm	ST	1	67,05	T&A 736
Rastex 25							
	0013116	4023149131165	ohne Abdeckrand, blank	ST	1	19,91	T&A 737
Abdeckkappen für Rastex 25							
	0013117	4023149131172	weiß	ST	1	4,68	T&A 737
Einschraubdübel Twister DU 262 T							
	0020060	4023149200601	Spannmaß 24,5 mm	ST	1	9,14	T&A 738









Unverbindliche Preisempfehlung. Preise gültig bei Abnahme von ganzen Verpackungseinheiten zzgl. MwSt.

	Kat-Nr	Händler/EAN	Artikelbeschreibung	ME	VPE	€ / 100*	Katalog / Seite
Einschraubdübel DU 643							
	0013121	4023149131219	Spannmaß 24,5 mm	ST	1	11,94	T&A 738
VB 20 mit Steg							
	0025049	4023149250491	für 19 - 20 mm Fachböden	ST	1	109,72	T&A 740
VB 21 ohne Steg							
	0047454	4023149474545	für 19 - 20 mm Fachböden	ST	1	124,53	T&A 740
Einschraubdübel DU 327							
	0025052	4023149250521	Spannmaß 9 mm	ST	1	18,59	T&A 741
Einschraubdübel DU 427							
	9134678	4023149080616	Spannmaß 9 mm	ST	1	18,35	T&A 741
Abdeckkappen							
	0047584	4023149475849	weiß, VB 20,21 ø 10 mm	ST	1	4,70	T&A 741

Verbindungstechnik

▶ Exzenter Verbindungs- Beschlag VB 35 / 36

▶ Dübel









	Kat-Nr	Händler/EAN	Artikelbeschreibung	ME	VPE	€ / 100*	Katalog / Seite
VB 35 M / 19 mit Steg							
	0065505	4023149655050	für 19 mm Fachböden, vernickelt	ST	1	42,66	T&A 742
	0065507	4023149655074	für 19 mm Fachböden, weiß	ST	1	22,86	T&A 742
VB 35 / 19 ohne Steg							
	0065513	4023149496271	für 19 mm Fachböden, vernickelt	ST	1	43,52	T&A 743
	0065515	4023149655159	für 19 mm Fachböden, weiß	ST	1	22,86	T&A 743
VB 36 M / 19 mit Steg							
	0065521	4023149655210	für 19 mm Fachböden, vernickelt	ST	1	57,97	T&A 744
	0065523	4023149655234	für 19 mm Fachböden, weiß	ST	1	29,92	T&A 744
VB 36 / 19 ohne Steg							
	0065529	4023149498039	für 19 mm Fachböden, vernickelt	ST	1	57,97	T&A 745
	0065531	4023149655319	für 19 mm Fachböden, weiß	ST	1	29,92	T&A 745
Einschraubdübel DU 328							
	0065540	4023149655401	Spannmaß 6,7 mm	ST	1	18,59	T&A 746
Einschraubdübel DU 321							
	0074688	4023149746888	Spannmaß 6,7 mm	ST	1	18,59	T&A 746
Einschraubdübel DU 322							
	0064872	4023149648724	Spannmaß 6,7 mm	ST	1	18,59	T&A 746
Einschraubdübel DU 426							
	0065370	4023149653704	Spannmaß 6,7 mm	ST	1	18,59	T&A 747

Unverbindliche Preisempfehlung. Preise gültig bei Abnahme von ganzen Verpackungseinheiten zzgl. MwSt.

Verbindungstechnik









► Verbindungsbeschläge

► VB Verbinder mit Form- und Kraftschluss / AVB Arbeitsplattenverbinder







	Kat-Nr	Händler/EAN	Artikelbeschreibung	ME	VPE	€ / 100*	Katalog / Seite
Doppeldübel DU 867							
	0065536	4023149655364	Spannmaß 6,7 mm	ST	1	55,75	T&A 747
VB 54 / 19 Toolex							
	0073619	4023149736193	Für Lochreihen ø 3 und 5 mm, zum Anschrauben Zinkdruckguss vernickelt, Kunststoff grau	ST	1	57,01	T&A 748
TZ 4							
	0020843	4023149208430	vernickelt	ST	1	95,66	T&A 750
	0013104	4023149131042	weiß	ST	1	38,74	T&A 750
TZ 4 STD							
	0020891	4023149208911	Vernickelt	ST	1	95,66	T&A 750
VB 25 T							
	9079555	4023149009297	Spannmaß 60 - 70 mm	ST	1	632,81	T&A 756
AVB 4							
	9079575	4023149009266	Länge 81 mm	ST	1	241,27	T&A 758
	9079579	4023149009273	Länge 116 mm	ST	1	272,74	T&A 758
	9079583	4023149009280	Länge 165 mm	ST	1	317,02	T&A 758
AVB 4 Slim							
	9085654	4023149026188	Länge 100 mm	ST	1	396,36	T&A 758
AVB 5							
	0025084	4023149250842	Länge 65 mm	ST	1	54,12	T&A 759
	0079386	4023149793868	Länge 100 mm	ST	1	60,17	T&A 759
	0016048	4023149160486	Länge 150 mm	ST	1	62,98	T&A 759

Verbindungstechnik

- ▶ MultiClip, Rückwandverbinder
- ▶ VB / Zubehör









	Kat-Nr	Händler/EAN	Artikelbeschreibung	ME	VPE	€ / 100*	Katalog / Seite
MultiClip							
	0046080	4023149460807	Thermoplast schwarz	ST	1	24,39	T&A 761
Rückwandverbinder RV 1							
	0019558	4023149195587	Zinkdruckguss vernickelt	ST	1	45,53	T&A 763
Rückwandverbinder RV 7 D							
	0056614	4023149566141	Zinkdruckguss vernickelt	ST	1	103,73	T&A 764
Direktbefestigungsschraube							
	0040007	4023149400070	ø 6,3 x 13 mm	ST	1	7,82	T&A 764
Muffe Nr. 100							
	0079540	4023149795404	M6	ST	1	4,27	T&A 770
Rückwandverbinder RV 8							
	0079438	4023149794384	Zur Fixierung von Schubkastenböden und Rückwänden, Kunststoff weiß	ST	1	13,07	T&A 400
VB 15							
	0079666	4023149796661	Stahl verzinkt	ST	1	37,04	T&A 766
Verbindungsplatte für Frontblenden							
	0044744	4023149447440	Länge 200 mm	ST	1	140,79	T&A 766
	0079664	4023149796647	Länge 80 mm	ST	1	44,99	T&A 766
Eurowinkel							
	0024832	4023149248320	für 32 mm Lochreihe	ST	1	46,87	T&A 767
	0050314	4023149503146	Abdeckkappe, weiß	ST	1	44,15	T&A 767

Unverbindliche Preisempfehlung. Preise gültig bei Abnahme von ganzen Verpackungseinheiten zzgl. MwSt.









	Kat-Nr	Händler/EAN	Artikelbeschreibung	ME	VPE	€ / 100*	Katalog / Seite
Universal-Eckverbinder							
	0044742	4023149447426	weiß	ST	1	57,03	T&A 767
	0044743	4023149447433	schwarz	ST	1	57,03	T&A 767
Universalwinkel							
	0025197	4023149251979	41,5 x 41,5 mm	ST	1	44,37	T&A 768
Universalwinkel							
	0079665	4023149796654	31 x 31 mm	ST	1	46,86	T&A 238
Linsenkopfbeschlag							
	0025193	4023149251931	42 mm	ST	1	34,37	T&A 768
	0025194	4023149251948	62 mm	ST	1	45,77	T&A 768
Direkta 2							
	0019556	4023149195563	ø 5 mm, 6, 3 x 50 mm	ST	1	11,34	T&A 769
Verbindungsschraube VHS 32							
	0079659	4023149796593	ø 5 mm, Plattendicke 28 - 36 mm	ST	1	17,94	T&A 769
	0079660	4023149796609	ø 5 mm, Plattendicke 36 - 44 mm	ST	1	21,09	T&A 769
Endschraube, M4							
	0079525	4023149795251	ø 9 mm, Länge 8 mm	ST	1	4,99	T&A 769

Verbindungstechnik

► Hülsen, Muffen, Schrauben, Abdeckkappen

	Kat-Nr	Händler/EAN	Artikelbeschreibung	ME	VPE	€ / 100*	Katalog / Seite
Gewindehülse M4							
	0063016	4023149630163	ø 5 mm, 15 mm Länge	ST	1	17,94	T&A 769
	0064908	4023149649080	ø 5 mm, 18 mm Länge	ST	1	17,94	T&A 769
Muffe							
	0040005	4023149400056	Nr. 49, ø 8 x 11 mm, für Gewinde M6	ST	1	4,17	T&A 770
	0079529	4023149795299	Nr. 30, ø 8 mm, für Gewinde M4	ST	1	6,16	T&A 770
Spreizmuffe							
	0048578	4023149485787	ø 5 x 7,8 mm, Messing blank	ST	1	14,02	T&A 771
Senkkopfschraube							
	0047451	4023149474514	Flacher Senkkopf, ø 6,3 x 11 mm	ST	1	5,17	T&A 772
	0047452	4023149474521	Steiler Senkkopf, ø 6,3 x 14 mm	ST	1	6,95	T&A 772
Blendenbefestigungsschraube							
	0076222	4023149408120	ø 5 x 14 mm	ST	1	8,26	T&A 773
	0052996	4023149529962	ø 5 x 16 mm	ST	1	7,41	T&A 773
Spezialschraube							
	0046700	4023149467004	ø 6,3 x 14 mm	ST	1	22,67	T&A 773
Rückwandschraube							
	0016190	4023149161902	ø 3 x 20 mm	ST	1	4,37	T&A 773
Abdeckkappe							
	0048586	4023149485862	Für Bohrdurchmesser 5 mm, weiß	ST	1	2,09	T&A 774
	0048588	4023149485886	Für Bohrdurchmesser 8 mm, weiß	ST	1	2,09	T&A 774
	0048590	4023149485909	Für Bohrdurchmesser 10 mm, weiß	ST	1	2,09	T&A 774

Unverbindliche Preisempfehlung. Preise gültig bei Abnahme von ganzen Verpackungseinheiten zzgl. MwSt.

	Kat-Nr	Händler/EAN	Artikelbeschreibung	ME	VPE	€ / 100*	Katalog / Seite
Bettverbindungsbeschlag							
	0025183	4023149251832	Höhe 130 mm	GN	1	589,35	T&A 787
Winkelbettbeschlag							
	0025189	4023149251894	Höhe 127 mm	ST	1	150,08	T&A 788
	0047635	4023149476358	Höhe 226 mm	ST	1	320,05	T&A 789
StabiloFix							
	0047634	4023149476341	Für zerlegbare Polsterbetten oder Bettkästen	ST	1	432,95	T&A 789
VariFix							
	0047633	4023149476334	Für Einzel- und Doppelbetten	ST	1	292,52	T&A 786
Stützfuß für Mittelbalken							
	0047632	4023149476327	Verstellung -42 / +76 mm	ST	1	237,25	T&A 787
Mittelbalkenverbinder							
	0025182	4023149251825	Für Bettkonstruktionen aus Holz und Metall	ST	1	176,13	T&A 786
Rastomat							
	0025175	4023149251757	Rastomat 5 für Kopf- und Fußteile	ST	1	752,29	T&A 781
	0025174	4023149251740	Rastomat 10 für Kopf- und Fußteile	ST	1	890,24	T&A 781
MultiFlex Verstellbeschlag							
	0025173	4023149251733	für Kopf- und Fußteile, Stahl verzinkt	ST	1	810,07	T&A 782
SchwenkFix							
	0030864	4023149308642	Für Truhen oder Eckbänke, Stahl verzinkt	GN	1	1.998,36	T&A 778

	Kat-Nr	Händler/EAN	Artikelbeschreibung	ME	VPE	€/ 100*	Katalog / Seite
Sockelfuß Korrekt							
	0044747	4023149447471	Sockelhöhe 50 mm	ST	1	54,76	T&A 794
	0044748	4023149447488	Sockelhöhe 70 mm	ST	1	54,76	T&A 794
	0070151	4023149701511	Sockelhöhe 80 mm	ST	1	53,38	T&A 794
	0061851	4023149618512	Sockelhöhe 100 mm	ST	1	53,98	T&A 794
	0070152	4023149701528	Sockelhöhe 110 mm	ST	1	54,12	T&A 794
	0061852	4023149618529	Sockelhöhe 130 mm	ST	1	56,72	T&A 794
	0020018	4023149200182	Sockelhöhe 150 mm	ST	1	63,58	T&A 794
	0061853	4023149618536	Sockelhöhe 150 mm	ST	1	59,47	T&A 794
	0070153	4023149701535	Sockelhöhe 180 mm	ST	1	63,59	T&A 794

Adapter für Sockelfuß							
	0071844	4023149718441	Kunststoff schwarz	ST	1	33,04	T&A 795

Gleiter Universal							
	0061854	4023149618543	zum Anschrauben	ST	1	30,96	T&A 795
	0047654	4023149476549	zum Einpressen mit 4 Dübeln	ST	1	52,76	T&A 795
	0047655	4023149476556	zum Einpressen mit 2 Dübeln	ST	1	52,76	T&A 795
	0079689	4023149796890	zum Einschlagen mit 2 Spreizdübeln	ST	1	52,76	T&A 796

Gleiter Planform zum Einschlagen mit 3 Spreizdübeln							
	0074667	4023149746673	zum Einschlagen mit 3 Spreizdübeln, mit Auflage	ST	1	63,07	T&A 796

Blendenhalter zum Aufklipsen auf den Sockelfuß							
	0073481	4023149734816	zum Einnuten	ST	1	17,70	T&A 797
	0061855	4023149618550	zum Anschrauben	ST	1	14,56	T&A 797

Verbindungstechnik

- ▶ Sockelfuß, Sockelversteller, Zubehör
- ▶ Verstellerschrauben, Bodenträger

	Kat-Nr	Händler/EAN	Artikelbeschreibung	ME	VPE	€ / 100*	Katalog / Seite
--	--------	-------------	---------------------	----	-----	----------	-----------------

Blendenhalter TurboClip



0079690	4023149796906	für Frontblenden	ST	1	41,17	T&A 797
----------------	---------------	------------------	----	---	-------	---------

Sockelverstellwerkzeug



9253384	4023149170515	Sockelverstellwerkzeug	ST	1	3.479,90	T&A 794
----------------	---------------	------------------------	----	---	----------	---------

Weitere Informationen finden Sie hier:
hettich.com/short/2a4b30



Sockelversteller Systema Top 2000



0040438	4023149404382	für Außenwand, 60 - 80 mm	ST	1	610,35	T&A 800
----------------	---------------	---------------------------	----	---	--------	---------

Verstellbeschlag



0031571	4023149315718	für Stollenwände	ST	1	181,86	T&A 803
----------------	---------------	------------------	----	---	--------	---------

Verstellerschraube



0047646	4023149476464	mit Gewinde M10, Stahl verzinkt	ST	1	198,22	T&A 803
----------------	---------------	---------------------------------	----	---	--------	---------

Bodenträger Safety



0016180	4023149161803	ø 5 mm, glasklar	ST	1	5,30	T&A 806
----------------	---------------	------------------	----	---	------	---------

0025090	4023149370717	ø 5 mm, weiß	ST	1	4,71	T&A 806
----------------	---------------	--------------	----	---	------	---------

Stiftbodenträger Sekura 1.1



0019557	4023149195570	Zapfendurchmesser 5 mm, vernickelt	ST	1	11,16	T&A 806
----------------	---------------	------------------------------------	----	---	-------	---------

Bodenträger Sekura 2



0025100	4023149251009	Zapfendurchmesser 5 mm, vernickelt	ST	1	11,25	T&A 806
----------------	---------------	------------------------------------	----	---	-------	---------





Bodenträger Sekura 2.1



9134679	4023149080623	Zapfendurchmesser 5 mm, vernickelt	ST	1	8,87	T&A 806
----------------	---------------	------------------------------------	----	---	------	---------

Verbindungstechnik









► Bodenträger

	Kat-Nr	Händler/EAN	Artikelbeschreibung	ME	VPE	€/ 100*	Katalog / Seite
Stiftbodenträger Sekura 6							
	0079707	4023149797071	Zapfendurchmesser 5 mm, vernickelt	ST	1	17,10	T&A 807
Stiftbodenträger Sekura 7							
	0053012	4023149530128	vernickelt, ø 5 mm	ST	1	17,21	T&A 807
Bodenträger Universal D							
	0022737	4023149227370	Zapfendurchmesser 5 mm, vernickelt	ST	1	8,88	T&A 807
Bodenträger Duplo							
	0046642	4023149466427	Zapfendurchmesser 5 mm, vernickelt	ST	1	1,95	T&A 807
	0013138	4023149131387	Zapfendurchmesser 5 mm, verzinkt	ST	1	1,50	T&A 807
Steckbodenträger							
	0025124	4023149251245	Bohrdurchmesser 5 mm	ST	1	3,86	T&A 808
	0016181	4023149161810	Zapfendurchmesser 5 mm mit Ansatz	ST	1	6,00	T&A 808
Sekura 8							
	0047609	4023149476099	Zapfendurchmesser 5 mm	ST	1	26,23	T&A 808
Glasbodenträger							
	0079710	4023149797101	ø 3 mm	ST	1	6,23	T&A 809
	0079709	4023149797095	ø 5 mm	ST	1	4,68	T&A 809
Löffelbodenträger							
	0020782	4023149207822	ø 5 mm, verzinkt	ST	1	3,05	T&A 809
Nutbodenträger							
	0074805	4023149748059	Zapfendurchmesser 5 mm, Zinkdruckgruss blank	ST	1	34,41	T&A 810
Fachbodensicherung							
	0063549	4023149635496	Zapfendurchmesser 5 mm, Kunststoff glasklar	ST	1	3,94	T&A 810

Unverbindliche Preisempfehlung. Preise gültig bei Abnahme von ganzen Verpackungseinheiten zzgl. MwSt.







Verbindungstechnik

- ▶ Bodenträger
- ▶ Regalbodenträger, Schrankaufhänger

	Kat-Nr	Händler/EAN	Artikelbeschreibung	ME	VPE	€ / 100*	Katalog / Seite
Bodenträger Vari Stahl							
	0013127	4023149131271	Bodenträger, 10 x 5 mm, verzinkt	ST	1	9,96	T&A 811
	0047612	4023149476129	Schiene, 10 x 5 mm, vernickelt	ST	1	903,74	T&A 811
Regalbodenträger Titan 1							
	0079713	4023149797132	mit Seitenverstellung, verzinkt	ST	1	281,79	T&A 812
Regalbodenträger Titan							
	0047661	4023149476617	Regalbodenträger Titan 1, verzinkt	ST	1	290,97	T&A 812
	0063598	4023149635984	Regalbodenträger Titan 2, verzinkt	ST	1	283,02	T&A 813
	0079714	4023149797149	Regalbodenträger Titan 3, verzinkt	ST	1	270,53	T&A 813
Regalbodenträgeraufnahme							
	9131119	4023149372247	Mit Neigungsausgleich	ST	1	4.545,02	T&A 815
Schrankaufhänger SAH 215 / SAH 216							
	0079716	4023149866609	SAH 215, 45 kg	GN	1	543,11	T&A 824
	0079717	4023149866708	SAH 216, 55 kg	GN	1	607,39	T&A 828
Abdeckkappen für SAH 215 / SAH 216							
	0079719	4023149797194	ø 15 mm, weiß	ST	1	4,38	T&A 826
Schrankaufhänger SAH 130, 130 kg							
	0079724	4023149797248	zur Montage im Korpus	GN	1	330,08	T&A 830
Schrankaufhänger SAH 15, 30 kg							
	9208645	4023149001208	SAH 15	ST	1	322,75	T&A 832

Verbindungstechnik

- ▶ Schrankaufhänger, Zubehör
- ▶ Aufhängeschienen, Zubehör

	Kat-Nr	Händler/EAN	Artikelbeschreibung	ME	VPE	€ / 100*	Katalog / Seite
Abdeckkappen für SAH 15							
	9208646	4023149001239	weiß	ST	1	39,51	T&A 832
	9208647	4023149001529	vernickelt	ST	1	88,36	T&A 832
Schrankaufhänger SAH 116, 40 kg							
	0019476	4023149194764	zum Anschrauben	GN	1	493,57	T&A 834
SAH 305, 15 kg							
	0040669	4023149406690	zur Montage in der Rückwand	ST	1	84,08	T&A 836
Aufhängeschiene Typ L, abknickbar, 130 kg							
	9208678	4023149517419	für SAH 15, 116, 130	ST	1	93,17	T&A 838
Universalaufhängeschiene Typ B, 150 kg							
	9007651	4023149654794	für SAH 15, 116, 130, 215 / 216	ST	1	1.471,59	T&A 838
Befestigungsmaterial							
	0046103	4023149461033	Aufhängehaken ø 6 x 50 mm und Mauerwerksdübel ø 8 x 40 mm	ST	1	32,80	T&A 839
	0065480	4023149654800	Spezialschraube ø 5,5 x 50 mm und Mauerwerksdübel ø 8 x 40 mm	ST	1	36,82	T&A 839
Puffer, selbstklebend							
	0041841	4023149421549	ø 13 mm, Kunststoff transparent	ST	1	25,41	T&A 841

Unverbindliche Preisempfehlung. Preise gültig bei Abnahme von ganzen Verpackungseinheiten zzgl. MwSt.

Schränkinnenausstattung

► Übersicht



Schränkinnenausstattung für Küchen
Dispensa Junior Slim

110



Schränkinnenausstattung für Küchen
Frontauszüge Cargo IQ plus 150, 200
und 300 mm

110



Schränkinnenausstattung für Küchen
Frontauszug Classic für Schrankbreite 150 mm

111



Schränkinnenausstattung für Küchen
Eckschrankschwenkauszug LeMans II
und Zubehör

111



Schränkinnenausstattung für Küchen
Falttür Eckschrandschwenkauszug Revo 90°

112



Schränkinnenausstattung für Wohnmöbel
Hochschrankausstattung Dispensa 90°
und Zubehör

112



Schränkinnenausstattung für Küchen und Bäder
Unterschrankausstattung Abfallsysteme,
Handtuchhalter, Wäschekörbe

112



Schränkinnenausstattung für Wohnmöbel
Kleiderlifte

114



Schränkinnenausstattung für Wohnmöbel
Ovale Schrankrohre und Schrankrohrlager

115



Schränkinnenausstattung für Wohnmöbel
Kleiderbügelhalter

116



Schränkinnenausstattung für Wohnmöbel
Ausziehbarer Hosenhalter

116



Schränkinnenausstattung für Wohnmöbel
Schuhschrankbeslag

116

Unverbindliche Preisempfehlung. Preise gültig bei Abnahme von ganzen Verpackungseinheiten zzgl. MwSt.

Schränkinnenausstattung



► Unterschrankausstattung



► Frontauszüge

	Kat-Nr	Händler/EAN	Artikelbeschreibung	ME	VPE	€ / 100*	Katalog / Seite
Dispensa Junior Slim							
	9277610	4023149214257	silber, lichte Korpushöhe 640 - 728 mm	ST	1	11.770,43	T&A 848
	9277621	4023149214264	silber, lichte Korpushöhe 695 - 793 mm	ST	1	11.941,95	T&A 848

Arena STYLE Rutschstopp Einhängetablar							
	9080084	4023149245701	Korpusbreite 300	ST	1	5.887,65	T&A 849

Arena CLASSIC Rutschstopp Einhängetablare							
	9277630	4023149214318	Korpusbreite 200	ST	1	5.313,61	T&A 849
	0013907	4023149860447	Korpusbreite 300	ST	1	5.305,31	T&A 849
	0013908	4023149860454	Korpusbreite 400	ST	1	6.000,38	T&A 849

Cargo IQ plus 150							
	9077588	4023149029547	Frontauszug für Schrankbreiten 150 mm, silber	ST	1	7.252,89	T&A 851
	9077601	4023149015724	Einlegeboden transluzent für Cargo 150	ST	1	411,54	T&A 851







Cargo IQ plus 200							
	9065857	4023149361302	Frontauszug für Schrankbreiten 200 mm, silber	ST	1	7.639,46	T&A 852
	9065861	4023149815546	Einlegeboden transluzent für Cargo 200	ST	1	788,36	T&A 852

Vollauszug Quadro V6 mit Dämpfung Silent System für Cargo IQ plus 150 und 200							
	9047289	4023149445958	EB 9,5 mm, Nennlänge 470 mm, Belastbarkeit 15 kg, Anschlag links, Korpusseitendicke 19 mm	ST	1	777,31	T&A 851
	9047290	4023149447013	EB 9,5 mm, Nennlänge 470 mm, Belastbarkeit 15 kg, Anschlag rechts, Korpusseitendicke 19 mm	ST	1	777,31	T&A 851
	9047452	4023149361685	EB 10,5 mm, Nennlänge 470 mm, Belastbarkeit 15 kg, Anschlag links, Korpusseitendicke 18 mm	ST	1	777,31	T&A 851
	9047453	4023149361692	EB 10,5 mm, Nennlänge 470 mm, Belastbarkeit 15 kg, Anschlag rechts, Korpusseitendicke 18 mm	ST	1	777,31	T&A 851

Schränkinnenausstattung

► Unterschrankausstattung

► Frontauszüge

	Kat-Nr	Händler/EAN	Artikelbeschreibung	ME	VPE	€ / 100*	Katalog / Seite
Cargo IQ plus 300							
	9065860	4023149360602	Frontauszug für Schrankbreiten 300 mm, silber	ST	1	8.278,58	T&A 853
	9065862	4023149048494	Einlegeboden transluzent für Cargo 300	ST	1	1.019,32	T&A 853
Vollauszug Quadro V6 mit Dämpfung Silent System							
	0045312	4023149453120	EB 9,5 mm, Nennlänge 470 mm, Belastbarkeit 15 kg, Korpusseitendicke 19 mm	GN	1	1.742,33	T&A 853
	0045307	4023149453076	EB 10,5 mm, Nennlänge 470 mm, Belastbarkeit 15 kg, Korpusseitendicke 18 mm	GN	1	1.742,33	T&A 853
Frontauszug CLASSIC							
	9207578	4023149719677	Frontauszug für Schrankbreiten 150 mm , verchromt	ST	1	12.827,41	T&A 854
Vollauszug Actro mit Dämpfung Silent System							
	9240576	4023149107290	EB 12 mm, Nennlänge 500 mm, Belastbarkeit 40 kg, Korpusseitendicke 19 mm, rechts	ST	1	986,77	.
	9239288	4023149097676	EB 13 mm, Nennlänge 500 mm, Belastbarkeit 40 kg, Korpusseitendicke 18 mm, rechts	ST	1	986,77	.
Tablar-Sets LeMans II							
	9136157	4023149066955	Reling Classic, Frontbreite 450 mm, links, verchromt	ST	1	32.556,18	T&A 866
	9136158	4023149066962	Reling Classic, Frontbreite 450 mm, rechts, verchromt	ST	1	32.556,18	T&A 866
	9136159	4023149066979	Reling Classic, Frontbreite 500 mm, links, verchromt	ST	1	34.095,37	T&A 866
	9136160	4023149066986	Reling Classic, Frontbreite 500 mm, rechts, verchromt	ST	1	34.095,37	T&A 866
	9136171	4023149066993	Reling Classic, Frontbreite 600 mm, links, verchromt	ST	1	36.769,52	T&A 866
	9136172	4023149067006	Reling Classic, Frontbreite 600 mm, rechts, verchromt	ST	1	36.769,52	T&A 866
Achsen für LeMans II							
	9132546	4023149477256	Lichte Korpushöhe 600 - 750 mm, weiß	ST	1	3.870,08	T&A 867
	9132547	4023149477263	Lichte Korpushöhe 720 - 900 mm, weiß	ST	1	4.643,50	T&A 867

Unverbindliche Preisempfehlung. Preise gültig bei Abnahme von ganzen Verpackungseinheiten zzgl. MwSt.

Schränkinnenausstattung

- ▶ Hochschrankausstattung
- ▶ Dispensa 90°, Zubehör

	Kat-Nr	Händler/EAN	Artikelbeschreibung	ME	VPE	€ / 100*	Katalog / Seite
--	--------	-------------	---------------------	----	-----	----------	-----------------

Dämpfung für LeMans II



9132399	4023149474606	links	ST	1	4.133,25	T&A 867
9132400	4023149474613	rechts	ST	1	4.133,25	T&A 867

Falttür Eckschränkdrehbeschlag Revo 90°



9080040	4023149124754	für lichte Schrankhöhen 660 - 860 mm	Set	1	20.477,93	T&A 870
----------------	---------------	--------------------------------------	-----	---	-----------	---------

Arena CLASSIC



0048679	4023149845574	Rutschstopp Tablarboden, Reling verchromt, 900 x 900 mm	ST	1	14.922,92	T&A 871
----------------	---------------	---	----	---	-----------	---------

Dispensa 90°, höhenverstellbarer Tragrahmen



9117200	4023149178610	Korpusbreite 262 mm, Korpushöhe 1600 - 2000 mm, silber	ST	1	15.927,77	T&A 922
9117211	4023149178627	Korpusbreite 262 mm, Korpushöhe 1900 - 2300 mm, silber	ST	1	16.012,50	T&A 922
9117213	4023149178641	Korpusbreite 362 mm, Korpushöhe 1600 - 2000 mm, silber	ST	1	16.038,29	T&A 922
9117214	4023149178658	Korpusbreite 362 mm, Korpushöhe 1900 - 2300 mm, silber	ST	1	16.086,18	T&A 922

Vollauszug mit niedriger Bauhöhe



9117223	4023149178740	Dispensa 90°, silber	ST	1	17.464,86	T&A 923
----------------	---------------	----------------------	----	---	-----------	---------







Öffnungsdämpfung



9162402	4023149607554	Für Vollauszug Dispensa 90°	ST	1	4.125,77	T&A 923
----------------	---------------	-----------------------------	----	---	----------	---------

Schrankinnenausstattung

- ▶ Unterschrankausstattung
- ▶ Abfallsysteme, Handtuchhalter, Wasserschutzmatte

	Kat-Nr	Händler/EAN	Artikelbeschreibung	ME	VPE	€/ 100*	Katalog / Seite
Arena CLASSIC Rutschstopp Einhängetablare							
	9082247	4023149019852	250 x 462 x 106 mm, silber	ST	1	5.036,01	T&A 849
	9082249	4023149019869	350 x 462 x 106 mm, silber	ST	1	5.695,74	T&A 849
	0013907	4023149860447	250 x 462 x 106 mm, verchromt	ST	1	5.305,31	T&A 849
	0013908	4023149860454	350 x 462 x 106 mm, verchromt	ST	1	6.000,38	T&A 849
Einhängkörbe mit 3-fach-Reling							
	0013909	4023149860461	250 x 467 x 110 mm, verchromt	ST	1	2.529,07	T&A 849
	0013910	4023149860478	350 x 467 x 110 mm, verchromt	ST	1	3.097,41	T&A 849
Einhängkörbe mit 2-fach-Reling							
	0073564	4023149735646	250 x 467 x 110 mm, verchromt	ST	1	2.290,35	T&A 849
	0073565	4023149735653	350 x 467 x 110 mm, verchromt	ST	1	2.729,16	T&A 849
Bin.it Classic							
	9079967	4023149013317	340 x 270 x 350 mm, 13 l, weiß	ST	1	3.855,30	T&A 905
	9079970	4023149013324	340 x 270 x 350 mm, 13 l, schwarz	ST	1	4.563,40	T&A 905
Bin.it Duo II 300							
	9132343	4023149374098	Bin.it Duo II 300	ST	1	11.497,91	T&A 910
Handtuchhalter							
	0049234	4023149492341	Ausziehbare und schwenkbare Handtuchhalter, 2, 102 mm	ST	1	5.849,25	T&A 876
Wasserschutzmatte							
	9079862	4023149245275	Schutz vor auslaufenden Flüssigkeiten im Spülenunterschrank, Breite 1200 mm x Tiefe 580 mm	ST	1	3.191,79	T&A 876

Unverbindliche Preisempfehlung. Preise gültig bei Abnahme von ganzen Verpackungseinheiten zzgl. MwSt.

Schränkinnenausstattung

- ▶ Kleiderlifte
- ▶ Schrankrohre

	Kat-Nr	Händler/EAN	Artikelbeschreibung	ME	VPE	€ / 100*	Katalog / Seite
Handtuchauszug							
	0070690	4023149706905	Länge 410 mm, 1-armig, Stahl / Kunststoff verchromt	ST	1	5.444,43	T&A 966
	0070692	4023149706929	Länge 410 mm, 2-armig, Stahl / Kunststoff verchromt	ST	1	5.707,10	T&A 966

Abgeschrägter Wäschekorb							
	0042392	4023149423925	328 x 250 x 440 mm, verchromt	ST	1	5.480,33	T&A 962
	0042393	4023149423932	420 x 250 x 440 mm, verchromt	ST	1	5.804,62	T&A 962
	0042397	4023149423970	328 x 350 x 440 mm, verchromt	ST	1	6.161,34	T&A 962
	0042462	4023149424625	420 x 350 x 440 mm, verchromt	ST	1	6.550,47	T&A 962

Halteleiste zum Anschrauben							
	0073596	4023149735967	verchromt	ST	1	950,09	T&A 962

Single Lift 12, 12 kg							
	9079872	4023149124075	links	ST	1	9.424,45	T&A 970
	9079874	4023149124082	rechts	ST	1	9.424,45	T&A 970

Duo Lift 10, 10 kg							
	9079878	4023149124105	750 - 1150 mm	ST	1	9.424,45	T&A 970

Duo Lift Basic 10, 10 kg							
	9079716	4023149244940	600 - 830 mm	ST	1	7.963,61	T&A 971
	9079720	4023149244957	830 - 1150 mm	ST	1	7.963,61	T&A 971

Schränkinnenausstattung

- ▶ Schrankrohlager
- ▶ Kleiderbügelhalter, Hosenhalter

	Kat-Nr	Händler/EAN	Artikelbeschreibung	ME	VPE	€/ 100*	Katalog / Seite
--	--------	-------------	---------------------	----	-----	---------	-----------------

Duo Lift 15, 15 kg



0042507	4023149425073	750 - 1150 mm	ST	1	11.226,77	T&A 971
----------------	---------------	---------------	----	---	-----------	---------

Duo Lift 18, 12 - 18 kg



9079882	4023149124129	750 - 1150 mm	ST	1	14.332,57	T&A 972
9079885	4023149124136	durch Distanzstück, 20 mm	ST	1	773,69	T&A 972

Ovales Schrankrohr



0047615	4023149476150	verchromt, hochglanz, Länge 2000 mm	ST	1	875,90	T&A 973
0047616	4023149016660	verchromt, hochglanz, Länge 5000 mm	ST	1	2.216,53	T&A 973
9079590	4023149008825	silber eloxiert, Länge 3000 mm	ST	1	1.296,82	T&A 973
9000894	4023149031120	vernickelt, matt, Länge 5000 mm	ST	1	1.407,24	T&A 973

Schrankrohlager



0070664	4023149706646	SL 322	ST	1	31,49	T&A 974
0070666	4023149706660	SL 323	ST	1	36,68	T&A 974
0070668	4023149706684	SL 786	ST	1	65,65	T&A 975

Mittellager SL 781



0070676	4023149706769	Mittellager SL 781	ST	1	101,12	T&A 975
----------------	---------------	--------------------	----	---	--------	---------

Schrankrohlager



9079719	4023149123290	Aluminium Optik lackiert	ST	1	69,98	T&A 976
----------------	---------------	--------------------------	----	---	-------	---------

Unverbindliche Preisempfehlung. Preise gültig bei Abnahme von ganzen Verpackungseinheiten zzgl. MwSt.

Schrankinnenausstattung

- ▶ Ablageschale
- ▶ Schuhschrankbeschlagn

Kat-Nr	Händler/EAN	Artikelbeschreibung	ME	VPE	€ / 100*	Katalog / Seite
--------	-------------	---------------------	----	-----	----------	-----------------

Kleiderbügelhalter mit Auszugsführung auf Quadro Basis



9136276	4023149486876	Lichte Korpushiefe 350 mm, silber	ST	1	4.378,03	T&A 977
9136277	4023149486869	Lichte Korpushiefe 400 mm, silber	ST	1	4.554,06	T&A 977
9136280	4023149486913	Lichte Korpushiefe 500 mm, silber	ST	1	4.730,02	T&A 977

Kleiderbügelhalter



0040279	4023149402791	Länge 310 mm, Stahl vernickelt	ST	1	651,38	T&A 977
----------------	---------------	--------------------------------	----	---	--------	---------

Ausziehbarer Hosenhalter Amari



9132916	4023149480041	für Lichte Korpushiefe 500 - 600 mm, silber, für 8 Hosenhalter	ST	1	13.239,93	T&A 979
9132917	4023149480058	für Lichte Korpushiefe 600 - 700 mm, silber, für 10 Hosenhalter	ST	1	13.789,23	T&A 979
9132918	4023149480065	für Lichte Korpushiefe 700 - 800 mm, silber, für 12 Hosenhalter	ST	1	14.404,06	T&A 979
9132919	4023149480072	für Lichte Korpushiefe 800 - 900 mm, silber, für 14 Hosenhalter	ST	1	15.166,51	T&A 979

Ablageschale



9132925	4023149480133	für Hosenhalter Amari	ST	1	943,65	T&A 979
----------------	---------------	-----------------------	----	---	--------	---------

Schuhschrankbeschlagn



0042473	4023149424731	1 Fach, Kunststoff weiß	GN	1	860,00	T&A 991
0042474	4023149424748	2 Fächer, Kunststoff weiß	GN	1	982,32	T&A 991
0042475	4023149424755	3 Fächer, Kunststoff weiß	GN	1	1.041,86	T&A 991



Prestige 2000
Zylinderdrehstangenschloss
Drehstangenschloss

118



Prestige 2000
Zylinderkastenschloss

118



Prestige 2000
Zylinderhebelschloss

118



Prestige 2000
Zylinderdruckschloss

119



Prestige 2000
Zylinderkastenschloss LAD

119



Prestige 2000
Zylinderfallenschloss

119



Prestige 2000
Zylinderschubstangenschloss

119



Prestige 2000
Zylinderschiebetürschloss

119



Prestige 2000
Drehgriffe und Möbelgriffe für Zylinderschlösser, auswechselbare Innenzylinder Z23, Demontageschlüssel, Hauptschlüssel, Ersatzschlüssel

120



Schlösser mit einfacher Schließung
Drehstangenschloss, Schlüssel, Schlüsselbuchsen

122



Mechanische Möbelschließsysteme
Zubehör

123



SafeFix 1, Magnetschnapper

124

Unverbindliche Preisempfehlung. Preise gültig bei Abnahme von ganzen Verpackungseinheiten zzgl. MwSt.

Möbelschließsysteme

► Prestige 2000

► Zylinder- drehstangen, - kasten, - hebel und Druckschlösser

	Kat-Nr	Händler/EAN	Artikelbeschreibung	ME	VPE	€ / 100*	Katalog / Seite
--	--------	-------------	---------------------	----	-----	----------	-----------------

Zylinderdrehstangenschloss Prestige 2000, Z23



9133906	4023149076275	ø 18 mm, zum Anschrauben, Dornmaß 15 mm, Länge 20 mm	ST	1	929,09	T&A 658
9133908	4023149076299	ø 18 mm, zum Anschrauben, Dornmaß 25 mm, Länge 20 mm	ST	1	929,09	T&A 658
9133912	4023149076336	ø 18 mm, zum Anschrauben, Dornmaß 15 mm, Länge 26 mm	ST	1	929,09	T&A 658
9133913	4023149076343	ø 18 mm, zum Anschrauben, Dornmaß 25 mm, Länge 26 mm	ST	1	948,51	T&A 658

Set Zylinderdrehstangenschloss Prestige 2000, Z23



9136128	4023149066863	ø 18 mm, zum Anschrauben, Dornmaß 15 mm, Länge 20 mm	ST	1	1.397,68	T&A 658
9136129	4023149066870	ø 18 mm, zum Anschrauben, Dornmaß 25 mm, Länge 20 mm	ST	1	1.397,68	T&A 658

Drehstangenschloss mit Innenvierkant



9206153	4023149004155	zum Anschrauben, Dornmaß 15 mm,	ST	1	616,76	T&A 660
9206154	4023149891090	zum Anschrauben, Dornmaß 25 mm	ST	1	626,24	T&A 660
9207073	4023149965579	zum Anschrauben, Dornmaß 15 mm	ST	1	925,15	T&A 660
9207074	4023149965623	zum Anschrauben, Dornmaß 25 mm	ST	1	939,37	T&A 660

Zylinderkastenschloss Prestige 2000, Z23



9133916	4023149076374	ø 18mm, Dornmaß 15 mm, Länge 20 mm	ST	1	799,83	T&A 662
9133917	4023149076381	ø 18mm, Dornmaß 25 mm, Länge 20 mm	ST	1	799,83	T&A 662

Zylinderkastenschloss variabel Prestige 2000, Z23



0079736	4023149797361	ø 18 mm, Dornmaß 15 - 40 mm	ST	1	990,01	T&A 663
----------------	---------------	-----------------------------	----	---	--------	---------









Zylinderhebelschloss Prestige 2000, Z23



0072502	4023149725029	ø 18 mm	ST	1	635,62	T&A 664
----------------	---------------	---------	----	---	--------	---------

Möbelschließsysteme

- ▶ Prestige 2000, auswechselbare Innenzylinder
- ▶ Zylinder- kasten, - fallen, - schubkastenschlösser, Zubehör

	Kat-Nr	Händler/EAN	Artikelbeschreibung	ME	VPE	€ / 100*	Katalog / Seite
Set Zylinderhebelschloss, Z23							
	0078020	4023149780202	ø 18 mm	ST	1	1.337,33	T&A 664
Zylinderdruckschloss, Z23							
	0072501	4023149725012	ø 18 mm	ST	1	1.104,30	T&A 665
Zylinderkastenschloss LAD Z23							
	0072300	4023149723001	ø 18 mm	ST	1	642,02	T&A 666
	0077894	4023149778940	ø 18 mm	ST	1	702,39	T&A 666
Zylinderfallenschloss, Z23							
	0045741	4023149457418	ø 18 mm	ST	1	1.165,59	T&A 667
Set Zylinderschubstangenschloss Z23							
	0077892	4023149778926	ø 18 mm, rechts	ST	1	1.605,02	T&A 668
Schubstange 10 x 3 mm							
	0072687	4023149726873	Länge 1000 mm	ST	1	681,44	T&A 669
Zylinderschiebetürschloss							
	9133926	4023149076473	für 2-türige Schiebetürschränke	ST	1	1.446,15	T&A 672
Zylinderdrehgriff Typ 471 N							
	9080740	4023149010569	Links	ST	1	1.508,77	T&A 684
	9080739	4023149010552	Rechts	ST	1	1.508,77	T&A 684

Unverbindliche Preisempfehlung. Preise gültig bei Abnahme von ganzen Verpackungseinheiten zzgl. MwSt.

Möbelschließsysteme

- ▶ Prestige 2000, auswechselbare Innenzylinder
- ▶ Zubehör, Möbelknöpfe

	Kat-Nr	Händler/EAN	Artikelbeschreibung	ME	VPE	€ / 100*	Katalog / Seite
--	--------	-------------	---------------------	----	-----	----------	-----------------

Zylinderdrehgriff Typ 451 N



9080759	4023149859441	Links	ST	1	943,69	T&A 684
9080758	4023149859434	Rechts	ST	1	943,69	T&A 684

Zylinderdrehgriff Typ 42.2



9206831	4023149952654	Links	ST	1	992,93	T&A 685
9206830	4023149952609	Rechts	ST	1	992,93	T&A 685

Demontagestift



9080761	4023149859465	Demontagestift	ST	1	503,77	T&A 688
----------------	---------------	----------------	----	---	--------	---------

Möbelknopf



9209183	4023149853739	Typ 474	ST	1	738,47	T&A 688
----------------	---------------	---------	----	---	--------	---------



9209182	4023149852879	Typ 454	ST	1	518,46	T&A 689
----------------	---------------	---------	----	---	--------	---------



9206835	4023149952951	Typ 424	ST	1	574,81	T&A 689
----------------	---------------	---------	----	---	--------	---------

Innenzylinder Z23 ø 18 mm



9078860	4023149120770	Schließkreis 18001 - 18020	ST	1	517,15	T&A 693
9078861	4023149120787	Schließkreis 18001 - 18050	ST	1	517,15	T&A 693
9105927	4023149043932	Schließkreis 18051 - 18100	ST	1	517,15	T&A 693
9101019	4023149055744	Schließkreis 18001 - 18500	ST	1	711,08	T&A 693

Möbelschließsysteme

► Prestige 2000, auswechselbare Innenzylinder

	Kat-Nr	Händler/EAN	Artikelbeschreibung	ME	VPE	€/ 100*	Katalog / Seite
Innenzylinder Z23 ø 18 mm							
	9078862	4023149120794	18001	ST	1	517,15	T&A 693
	9078865	4023149120800	18002	ST	1	517,15	T&A 693
	9078867	4023149120817	18003	ST	1	517,15	T&A 693
	9078871	4023149120824	18004	ST	1	517,15	T&A 693
	9078874	4023149120831	18005	ST	1	517,15	T&A 693
	9078877	4023149120848	18006	ST	1	517,15	T&A 693
	9078878	4023149120855	18007	ST	1	517,15	T&A 693
	9078886	4023149120862	18008	ST	1	517,15	T&A 693
	9078888	4023149120879	18009	ST	1	517,15	T&A 693
	9078890	4023149120886	18010	ST	1	517,15	T&A 693
	9078894	4023149120893	18011	ST	1	517,15	T&A 693
	9078 899	4023149120909	18012	ST	1	517,15	T&A 693
	9078 902	4023149120916	18013	ST	1	517,15	T&A 693
	9078 904	4023149120923	18014	ST	1	517,15	T&A 693
	9078911	4023149120930	18015	ST	1	517,15	T&A 693
	9078912	4023149120947	18016	ST	1	517,15	T&A 693
	9078915	4023149120954	18017	ST	1	517,15	T&A 693
	9078917	4023149120961	18018	ST	1	517,15	T&A 693

Unverbindliche Preisempfehlung. Preise gültig bei Abnahme von ganzen Verpackungseinheiten zzgl. MwSt.

Möbelschließsysteme

- ▶ Prestige 2000, auswechselbare Innenzylinder
- ▶ Demontage-, Generalhaupt-, Haupt-, Ersatzschlüssel, Drehstangenschlösser

	Kat-Nr	Händler/EAN	Artikelbeschreibung	ME	VPE	€ / 100*	Katalog / Seite
	9078920	4023149120978	18019	ST	1	517,15	T&A 693
	9078922	4023149120985	18020	ST	1	517,15	T&A 693
	9078925	4023149120992	18021	ST	1	517,15	T&A 693
	9078926	4023149121005	18022	ST	1	517,15	T&A 693
	9078928	4023149121012	18023	ST	1	517,15	T&A 693
	9078929	4023149121029	18024	ST	1	517,15	T&A 693
	9078930	4023149121036	18025	ST	1	517,15	T&A 693

Demontageschlüssel



0072509	4023149725098	für Z23 / Z32 und Z25-Innenzylinder	ST	1	598,08	T&A 698
---------	---------------	-------------------------------------	----	---	--------	---------

Generalhauptschlüssel



9078980	4023149013133	Generalhauptschlüssel	ST	1	1.901,93	T&A 699
---------	---------------	-----------------------	----	---	----------	---------

Z23 / Z25 Hauptschlüssel



9078982	4023149013140	Schließkreis 18001 - 18500	ST	1	1.846,27	T&A 699
---------	---------------	----------------------------	----	---	----------	---------

Z23 / Z25 Ersatzschlüssel Schließplan



9112981	4023149060755	Schließkreis 18001 - 18500	ST	1	104,38	T&A 699
---------	---------------	----------------------------	----	---	--------	---------









Drehstangenschloss, zum Anschrauben



0072214	4023149722141	Dornmaß 15 mm, links	ST	1	422,63	T&A 702
0072213	4023149722134	Dornmaß 15 mm, rechts	ST	1	422,63	T&A 702
0072217	4023149722172	Dornmaß 25 mm, rechts	ST	1	422,63	T&A 702

Möbelschließsysteme

- ▶ Drehstangenschlösser
- ▶ Schlösser mit einfacher Schließung, Zubehör







	Kat-Nr	Händler/EAN	Artikelbeschreibung	ME	VPE	€ / 100*	Katalog / Seite
Set Drehstangenschloss zum Anschrauben							
	0077884	4023149778841	Dornmaß 25 mm, links	ST	1	936,00	T&A 702
	0077883	4023149778834	Dornmaß 25 mm, rechts	ST	1	936,00	T&A 702
Schlüssel Typ 08							
	0044565	4023149445651	vernickelt, matt	ST	1	202,99	T&A 705
Schlüssel Typ 09							
	0048596	4023149485961	vernickelt, hochglanz	ST	1	118,23	T&A 705
Schlüsselbuchse Typ 2175							
	0044560	4023149445606	vernickelt, matt	ST	1	188,59	T&A 706
Drehstange 6 / 5							
	0072251	4023149722516	Länge 1000 mm	ST	1	183,40	T&A 709
	0072253	4023149722530	Länge 1500 mm	ST	1	277,84	T&A 709
Schließhaken							
	0072266	4023149722660	rechts, zum Anschrauben	ST	1	129,66	T&A 709
	0072267	4023149722677	links, zum Anschrauben	ST	1	129,66	T&A 709
Stangenführung							
	0072274	4023149722745	zum Anschrauben	ST	1	63,97	T&A 709
Anschlagstift							
	0058797	4023149587979	vernickelt	ST	1	53,55	T&A 711
Anschlagwinkel Typ 3011							
	0030125	4023149301254	Stahl vernickelt	ST	1	33,38	T&A 712



Unverbindliche Preisempfehlung. Preise gültig bei Abnahme von ganzen Verpackungseinheiten zzgl. MwSt.

Möbelschließsysteme

► SafeFix

► Magnetschnäpper

	Kat-Nr	Händler/EAN	Artikelbeschreibung	ME	VPE	€ / 100*	Katalog / Seite
SafeFix 1							
	9277856	4023149216084	Komplettsset	ST	1	1.612,01	T&A 718
	9277857	4023149216091	Anschlagwinkel + Schloss	ST	1	746,90	T&A 718
	9277858	4023149216107	Magnetknopf	ST	1	854,37	T&A 718
	9277859	4023149216114	Schablone	ST	1	209,56	T&A 718
Haftmagnetschnäpper							
	0046294	4023149462948	LM 5402 40 N, vernickelt	ST	1	911,32	T&A 721
	0046287	4023149462870	LM 5103 40 N, vernickelt	ST	1	1.400,98	T&A 721
	0046291	4023149462917	LM 5103 80 N, vernickelt	ST	1	2.690,41	T&A 721
Fangmagnetschnäpper							
	0013149	4023149131493	M 64/GP 5 50 N, weiß passiviert	ST	1	387,46	T&A 722
Fangmagnetschnäpper							
	0013153	4023149131530	M 92/GP 7 40 N, weiß passiviert	ST	1	303,02	T&A 722
	0013155	4023149131554	M 93/GP 8 50 N, weiß passiviert	ST	1	407,41	T&A 722
Haftmagnetschnäpper							
	0013157	4023149131578	M 73/GP 9 40 N, weiß passiviert	ST	1	46,85	T&A 723
	0013158	4023149131585	M 73/GP 9 40 N, braun passiviert	ST	1	46,85	T&A 723
Haftmagnetschnäpper							
	0013139	4023149131394	M 71/GP 1 40 N, weiß passiviert	ST	1	38,97	T&A 723
	0013140	4023149131400	M 71/GP 1 40 N, braun passiviert	ST	1	38,97	T&A 723

	Kat-Nr	Händler/EAN	Artikelbeschreibung	ME	VPE	€ / 100*	Katalog / Seite
Haftmagnetschnäpper							
	0013141	4023149131417	M 71/GP 2 50 N, weiß passiviert	ST	1	49,34	T&A 723
	0013142	4023149131424	M 71/GP 2 50 N, braun passiviert	ST	1	49,34	T&A 723



Schreibtisch Unterschrank
Containersets Systema Top 2000

128



Schreibtisch Unterschrank
Schreibtischcontainer Systema Top 2000
Einzelteile

128



Schreibtisch Unterschrank
Schließsystem für Schreibtischcontainer
Systema Top 2000

129



Schreibtisch Unterschrank
Zubehör und Organisationselemente
Systema Top 2000

131



Schreibtisch Unterschrank
Minicontainer Systema Top 2000

133



Tischgestelle Change Top Eco
Tischbeine Efua und Ayo

134



Schreibtisch und Bürozubehör
PC Halterung, Tastaturauszüge, Fernsehauszug
Kabelorganisation

134



Schrankwand
Hängeregistraturrahmen Schranktiefe 400 mm
Systema Top 2000

136



Schrankwand
Breitwandschub Schranktiefe 400 mm
Systema Top 2000

137



Schrankwand
Hängeregistraturrahmen Schranktiefe 600 mm
Systema Top 2000

137



Schrankwand
Breitwandschub Schranktiefe 600 mm
Systema Top 2000

138



Schrankwand
Schließsystem Stop Control
für Systema Top 2000

138

Unverbindliche Preisempfehlung. Preise gültig bei Abnahme von ganzen Verpackungseinheiten zzgl. MwSt.

Büromöbelsysteme

- ▶ Containersets
- ▶ Schreibtisch Unterschrank, Schreibmaterialschale

	Kat-Nr	Händler/EAN	Artikelbeschreibung	ME	VPE	€ / 100*	Katalog / Seite
--	--------	-------------	---------------------	----	-----	----------	-----------------

Container-Set mit Teilauszügen



0020711	4023149207112	392 x 530 mm, Aluminium Optik	GN	1	19.910,31	T&A 1080
0077602	4023149776021	392 x 530 mm, schwarz	GN	1	23.098,57	T&A 1080

Container-Set mit Vollauszügen



0041064	4023149410642	392 x 530 mm, Aluminium Optik	GN	1	23.664,55	T&A 1082
0041065	4023149410659	392 x 730 mm, Aluminium Optik	GN	1	25.599,75	T&A 1082
0041062	4023149410628	392 x 530 mm, schwarz	GN	1	23.098,57	T&A 1082
0041063	4023149410635	392 x 730 mm, schwarz	GN	1	24.993,12	T&A 1082

Container-Set mit Voll- und Überauszügen



0046748	4023149467486	392 x 530 mm, Aluminium Optik	GN	1	22.119,71	T&A 1083
0046751	4023149467516	392 x 730 mm, Aluminium Optik	GN	1	24.168,24	T&A 1083
0046744	4023149467448	392 x 530 mm, schwarz	GN	1	21.489,02	T&A 1083
0046746	4023149467462	392 x 730 mm, schwarz	GN	1	23.474,35	T&A 1083

Schreibmaterialschale, Höhe 25 mm



9007183	4023149031472	392 mm, Aluminium Optik	ST	1	675,11	T&A 1088
1079061	4023149030208	392 mm, schwarz	ST	1	655,52	T&A 1088







Schreibmaterialschale, Höhe 40 mm



9086348	4023149089954	392 mm, schwarz	ST	1	985,30	T&A 1088
9111484	4023149051098	392 mm, Aluminium Optik	ST	1	1.014,89	T&A 1088

Büromöbelsysteme







- ▶ Schreibtisch Unterschrank
- ▶ Schließsystem, Schubkasten, Auszugsführungen, Zubehör

	Kat-Nr	Händler/EAN	Artikelbeschreibung	ME	VPE	€/ 100*	Katalog / Seite
Blendenanbindung							
	1041577	4023149159688	mit Zapfen, schwarz	ST	1	199,12	T&A 1089
	9004472	4023149190957	ohne Zapfen, schwarz	ST	1	199,12	T&A 1089
Auszugsführung Quadro 12							
	0074862	4023149748622	links und rechts, für Schreibmaterialzug	GN	1	1.348,43	T&A 1090
Auszugsführungen Quadro 12 Silent System							
	9078565	4023149120114	links und rechts, für Schreibmaterialzug	GN	1	2.166,11	T&A 1090
Zylinderhebelschloss Prestige 2000							
	0074879	4023149748790	ø 18 mm, Z23	ST	1	970,52	T&A 1125
Verriegelungsstangen Stop Control							
	9080099	4023149015045	7 HE +1	ST	1	628,47	T&A 1122
	9080107	4023149015076	9 HE +1	ST	1	950,02	T&A 1122
	9080109	4023149015083	10 HE +1	ST	1	1.005,58	T&A 1122
Stahlschubkasten mit vormontiertem Zugstück							
	0020722	4023149093760	392 x 530 mm, Aluminium Optik	ST	1	2.056,12	T&A 1092
	0020532	4023149386275	392 x 730 mm, Aluminium Optik	ST	1	2.362,10	T&A 1092
	9061152	4023149952449	392 x 530 mm, schwarz	ST	1	1.958,21	T&A 1092
	9061151	4023149028328	392 x 730 mm, schwarz	ST	1	2.249,60	T&A 1092

Unverbindliche Preisempfehlung. Preise gültig bei Abnahme von ganzen Verpackungseinheiten zzgl. MwSt.

Büromöbelsysteme

- ▶ Schreibtisch Unterschrank
- ▶ Schließsystem, Schubkasten, Auszugsführungen, Zubehör

	Kat-Nr	Händler/EAN	Artikelbeschreibung	ME	VPE	€ / 100*	Katalog / Seite
Exzentrerscheiben							
	9186461	4023149830488	Für vertikale und horizontale Ausrichtung der Schubkastenblende	ST	1	61,09	T&A 1094
Kugelauszugsführung KA 270, 25 kg							
	0074863	4023149748639	Min. Einbautiefe 530 mm	GN	1	1.143,27	T&A 1095
	0074864	4023149748646	Min. Einbautiefe 730 mm	GN	1	1.262,05	T&A 1095
Auszugsführung Quadro Duplex 25, 25 kg							
	0041083	4023149410833	Min. Einbautiefe 530 mm	GN	1	3.600,58	T&A 1096
	0041085	4023149410857	Min. Einbautiefe 730 mm	GN	1	3.815,86	T&A 1096
Auszugsführung Quadro Duplex 45, 45 kg							
	0074865	4023149748653	400 mm, links und rechts, Lochreihe 32 mm (Garnitur)	GN	1	3.708,59	T&A 1097
	0074866	4023149748660	400 mm, links und rechts, Lochreihe 32 mm (Garnitur)	GN	1	3.930,33	T&A 1097
Selbsteinzugsgehäuse Stop Control							
	1055525	4023149028939	rechts, schwarz	ST	1	179,73	T&A 1099
Selbsteinzugsgehäuse Stop Control mit Silent System							
	0044389	4023149443893	rechts, schwarz	ST	1	608,32	T&A 1099
Selbsteinzugsgehäuse Stop Control mit Silent System 40							
	9186465	4023149830617	rechts, alu	ST	1	932,63	T&A 1100
	9186464	4023149830594	rechts, schwarz	ST	1	930,40	T&A 1100

	Kat-Nr	Händler/EAN	Artikelbeschreibung	ME	VPE	€ / 100*	Katalog / Seite
Steckbarer Hängerahmen							
	9039927	4023149886348	Aluminium Optik, 510 x 244 x 350 mm	ST	1	1.711,54	T&A 1111
	9039924	4023149903991	schwarz, 510 x 244 x 350 mm	ST	1	1.630,04	T&A 1111
	9039923	4023149886362	Aluminium Optik, 710 x 244 x 350 mm	ST	1	1.996,77	T&A 1111
	9039921	4023149022197	schwarz, 710 x 244 x 350 mm	ST	1	1.901,70	T&A 1111

	Blendenstütze, Schreibtischcontainer, EB 392 mm						
	0020571	4023149205712	Aluminium Optik	GN	1	454,50	T&A 1101
	0075554	4023149755545	Blendenstütze, schwarz	GN	1	432,84	T&A 1101
	9 186 462	4023149830532	Einstellbare Blendenstütze, Stahl, Aluminium Optik, links und rechts	GN	1	625,60	T&A 1101
	9 186 463	4023149830556	Einstellbare Blendenstütze, Stahl, schwarz, links und rechts	GN	1	595,75	T&A 1101







	Trennwand 392mm						
	9007204	4023149031496	Aluminium Optik, Kunststoff	ST	1	252,79	T&A 1106
	9007199	4023149031489	Aluminium Optik, Stahl	ST	1	561,58	T&A 1106
	1041576	4023149014000	schwarz, Kunststoff	ST	1	245,44	T&A 1106
	1040519	4023149028670	schwarz, Stahl	ST	1	534,83	T&A 1106







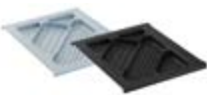

	Formularablage Set 6						
	0020576	4023149205767	392 mm, Aluminium Optik	ST	1	4.193,36	T&A 1112
	0075498	4023149754982	392 mm, schwarz	ST	1	4.071,22	T&A 1112

Büromöbelsysteme

► Rollen

► Zubehör Systema Top 2000

	Kat-Nr	Händler/EAN	Artikelbeschreibung	ME	VPE	€ / 100*	Katalog / Seite
Rolltraverse							
	9133143	4023149076046	350 kg, Kunststoff schwarz	ST	1	4.692,79	T&A 1114
Lenkrolle zum Einstecken in Rolltraverse							
	0046414	4023149464140	harte Böden	ST	1	710,10	T&A 1115
	0075572	4023149755729	weiche Böden	ST	1	291,08	T&A 1115
Dilip drive Container-Lenkrolle							
	9078539	4023149120053	25 mm	ST	1	255,09	T&A 1116
Bala drive Design-Zwillingsrolle							
	9078512	4023149130267	mit Gleitlager	ST	1	1.002,90	T&A 1117
Bala d-lock Zwillingsrolle							
	9078515	4023149130274	mit Radfeststeller und Gleitlager	ST	1	1.079,68	T&A 1117
Asim fix Seitenrolle							
	0002809	4008057028097	für Hartböden mit Gleitlager	ST	1	211,38	T&A 1117
Avin fix Kastenrolle							
	0002813	4008057028134	für Hartböden mit Gleitlager 30 mm	ST	1	156,41	T&A 1117
Schreibmaterialschale 392 mm							
	9082379	4023149020070	Aluminium Optik	ST	1	859,18	T&A 1088
	9065669	4023149022296	schwarz	ST	1	834,15	T&A 1088

	Kat-Nr	Händler/EAN	Artikelbeschreibung	ME	VPE	€/ 100*	Katalog / Seite
Blendenanbindung							
	1041577	4023149159688	mit Zapfen, schwarz	ST	1	199,12	T&A 1089
	9004472	4023149190957	ohne Zapfen	ST	1	199,12	T&A 1089
Quadro 12, 12 kg							
	9082378	4023149020063	Lochreihe 32 mm, EB 392 mm, für Schreibmaterialauszug	GN	1	1.348,43	T&A 1090
Auszugsführungen Quadro 12 Silent System, 12 kg							
	9134766	4023149950070	Nur für Schreibmaterialauszug	GN	1	2.166,11	T&A 1090
Stahlschubkasten für Minicontainer 392 mit vormontiertem Zugstück							
	9134405	4023149491160	Aluminium Optik, 392 x 400 mm	ST	1	2.105,57	T&A 1092
	9134400	4023149491313	schwarz, 392 x 400 mm	ST	1	2.005,30	T&A 1092
Exzentrerscheiben							
	9186461	4023149830488	Für vertikale und horizontale Ausrichtung der Schubkastenblende	ST	1	61,09	T&A 1094
Auszugsführung Quadro Duplex 30, 30 kg							
	9136065	4023149066696	Überszug mit Differentialrolle	ST	1	3.288,01	T&A 1098
Selbsteinzugsgehäuse Stop Control							
	1055525	4023149028939	rechts, schwarz	ST	1	179,73	T&A 1099
Selbsteinzugsgehäuse Stop Control mit Silent System							
	0044389	4023149443893	rechts, schwarz	ST	1	608,32	T&A 1099

Büromöbelsysteme

- ▶ Tisch- und Büroorganisation
- ▶ Tischgestell, Tischbeine, PC-Halterung

	Kat-Nr	Händler/EAN	Artikelbeschreibung	ME	VPE	€ / 100*	Katalog / Seite
--	--------	-------------	---------------------	----	-----	----------	-----------------

Tischgestell Change Top / Eco



9277885	4023149216213	Change Top Eco silber	ST	1	44.941,99	T&A 1268
9277886	4023149216220	Change Top Eco schwarz	ST	1	44.941,99	T&A 1268
9277887	4023149216237	Change Top Eco weiss	ST	1	44.941,99	T&A 1268

Efua 710 mm



0070135	4023149701351	ø 60 mm, Edelstahl Optik	GN	1	7.284,03	T&A 1296
0070144	4023149701443	ø 80 mm, Edelstahl Optik	GN	1	11.629,55	T&A 1296

Ayo 1200 mm



0046049	4023149460494	ø 60 mm, Edelstahl Optik	ST	1	5.194,10	T&A 1300
----------------	---------------	--------------------------	----	---	----------	----------

PC-Halterung PRO



9078797	4023149120633	PC-Halterung PRO	ST	1	14.825,92	T&A 1312
----------------	---------------	------------------	----	---	-----------	----------

PC-Halterung Lock



0048306	4023149483066	Aluminium Optik	ST	1	15.446,87	T&A 1313
----------------	---------------	-----------------	----	---	-----------	----------

PC-Halterung Basic



9078795	4023149120626	PC-Halterung Basic	ST	1	5.346,71	T&A 1314
----------------	---------------	--------------------	----	---	----------	----------

Kugelauszug KA 3434 für Tastaturauszüge











0077800	4023149778001	Belastbarkeit 20 kg, Nennlänge 300 mm	GN	1	2.477,12	T&A 1315
0077801	4023149778018	Belastbarkeit 20 kg, Nennlänge 350 mm	GN	1	2.617,34	T&A 1315
0077802	4023149778025	Belastbarkeit 20 kg, Nennlänge 400 mm	GN	1	3.037,96	T&A 1315

Büromöbelsysteme

► Zubehör

► Kabeldurchlässe

	Kat-Nr	Händler/EAN	Artikelbeschreibung	ME	VPE	€ / 100*	Katalog / Seite
Kabeldurchlass Kunststoff / Bürste rund							
	0045861	4023149458613	ø 60 mm, Edelstahl Optik	ST	1	1.846,08	T&A 1337
	0045871	4023149458712	ø 80 mm, Edelstahl Optik	ST	32	2.371,58	T&A 1337
	9081331	4023149014741	ø 60 mm, Aluminium Optik	ST	1	437,89	T&A 1340
Kabeldurchlass Kunststoff rund							
	9131024	4023149068751	ø 60 mm, Chrom Optik matt	ST	1	224,14	T&A 1339
	9131025	4023149068768	ø 80 mm, Chrom Optik matt	ST	1	295,01	T&A 1339
	0030847	4023149371950	ø 60 mm, weiß	ST	1	162,59	T&A 1339
	0047914	4023149065361	ø 80 mm, weiß	ST	1	243,39	T&A 1339
	0058588	4023149068720	ø 60 mm, grau	ST	1	165,76	T&A 1339
	0058590	4023149068737	ø 80 mm, grau	ST	1	241,58	T&A 1339
	0073747	4023149068775	ø 60 mm, schwarz	ST	1	162,59	T&A 1339
	0073748	4023149068782	ø 80 mm, schwarz	ST	1	221,08	T&A 1339
	0030848	4023149068706	ø 60 mm, braun	ST	1	153,47	T&A 1340
	0047915	4023149068713	ø 80 mm, braun	ST	1	225,37	T&A 1340
	9131028	4023149068799	ø 60 mm, Buche Optik	ST	1	150,55	T&A 1340
	9131029	4023149068805	ø 80 mm, Buche Optik	ST	1	221,08	T&A 1340

Unverbindliche Preisempfehlung. Preise gültig bei Abnahme von ganzen Verpackungseinheiten zzgl. MwSt.

Büromöbelsysteme

► Kabelhalter

► Schrankwand, Hängeregisterrahmen und Breitwandschub Schranktiefe 400 mm

	Kat-Nr	Händler/EAN	Artikelbeschreibung	ME	VPE	€ / 100*	Katalog / Seite
Kabelhalter							
	0045968	4023149459689	einfach	ST	1	102,00	T&A 1242

	0045969	4023149459696	doppelt	ST	1	136,87	T&A 1242
---	----------------	---------------	---------	----	---	--------	----------

Hängeregisterrahmen Schranktiefe 400 mm

	1051428	4023149028762	736 x 352 mm, schwarz	ST	1	4.154,13	T&A 1160
	1054417	4023149028823	936 x 352 mm, schwarz	ST	1	4.719,62	T&A 1160
	9007214	4023149031533	736 x 352 mm, Aluminium Optik	ST	1	4.361,84	T&A 1160
	9011908	4023149021541	936 x 352 mm, Aluminium Optik	ST	1	4.955,60	T&A 1160

Zwischensteg, Schränke mit Blenden, Schranktiefe 400 mm

	9039362	4023149022142	schwarz	ST	1	327,43	T&A 1111
	9039372	4023149022166	Aluminium Optik	ST	1	337,24	T&A 1111

Quadro Duplex 60, 60 kg

	9078681	4023149120275	für Korpusbauweise, X = 13 mm	GN	1	4.607,62	T&A 1163
	9078694	4023149120282	für Endlosbauweise, X = 22 mm	GN	1	4.670,01	T&A 1163

Direktbefestigungsschraube

	9137686	4023149095528	ø 6,0 x 13,7 mm	ST	1	14,00	T&A 1134
---	----------------	---------------	-----------------	----	---	-------	----------





Selbststeinzuggehäuse

	9 078 709	4023149120299	für Korpusbauweise X = 13 mm	GN	1	638,73	T&A 1165
	9 078 710	4023149120305	für Endlosbauweise X = 22 mm	GN	1	702,58	T&A 1165

Büromöbelsysteme

► Zubehör

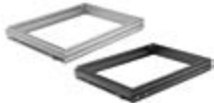
► Schrankwand, Hängeregisterrahmen und Breitwandschub Schranktiefe 600 mm

	Kat-Nr	Händler/EAN	Artikelbeschreibung	ME	VPE	€/ 100*	Katalog / Seite
Selbsteinzugsgehäuse mit Silent System							
	9078711	4023149120312	für Korpusbauweise X = 13 mm	GN	1	1.961,77	T&A 1165
	9078712	4023149120329	für Endlosbauweise X = 22 mm	GN	1	2.025,66	T&A 1165
Blendenstütze							
	0020592	4023149205927	Aluminium Optik	GN	1	503,02	T&A 1167
	0075555	4023149755552	schwarz	GN	1	488,38	T&A 1167
Breitwandschub für Schrankwände, Schranktiefe 400 mm							
	1054134	4023149028793	schwarz, 736 x 352 mm	ST	1	6.053,81	T&A 1162
	9007215	4023149031540	Aluminium Optik, 736 x 352 mm	ST	1	6.356,49	T&A 1162
Hängeregisterrahmen, Schranktiefe 600 mm							
	9011942	4023149021695	736 x 517 mm, Aluminium Optik	ST	1	5.522,13	T&A 1170
	1051431	4023149028779	736 x 517 mm, schwarz	ST	1	5.259,17	T&A 1170
Zwischensteg, Schränke mit Blenden, Schranktiefe 600 mm							
	0048428	4023149484285	Aluminium Optik	ST	1	384,27	T&A 1198
	9039373	4023149022173	schwarz	ST	1	373,09	T&A 1198
Quadro Duplex 70, 65 kg							
	9078717	4023149120336	für Korpusbauweise, X = 13 mm	GN	1	5.772,93	T&A 1173
	9078719	4023149120343	für Endlosbauweise, X = 22 mm	GN	1	5.836,80	T&A 1173

Unverbindliche Preisempfehlung. Preise gültig bei Abnahme von ganzen Verpackungseinheiten zzgl. MwSt.

Büromöbelsysteme

- ▶ Schrankwand, Hängeregisterrahmen und Breitwandschub Schranktiefe 600 mm
- ▶ Zubehör, Schreibplattenauszug Quadro 25, Schließsystem

	Kat-Nr	Händler/EAN	Artikelbeschreibung	ME	VPE	€ / 100*	Katalog / Seite
--	--------	-------------	---------------------	----	-----	----------	-----------------

Breitwandschub für Schrankwände, Schranktiefe 600 mm



1065664	4023149032226	536 x 517 mm, schwarz	ST	1	6.430,78	T&A 1172
1065665	4023149032233	736 x 517 mm, schwarz	ST	1	7.347,34	T&A 1172
9011947	4023149021749	536 x 517 mm, Aluminium Optik	ST	1	6.752,31	T&A 1172
9011948	4023149021756	736 x 517 mm, Aluminium Optik	ST	1	7.714,72	T&A 1172

OrgaLine



9078219	4023149022319	schwarz, AB 736 mm	GN	1	2.441,14	T&A 1194
9078227	4023149022388	Aluminium Optik, AB 736 mm	GN	1	2.563,18	T&A 1194

Schreibplattenauszug Quadro 25, 25 kg



0056014	4023149560149	mit Rücklaufarretierung	GN	1	2.191,14	T&A 1211
----------------	---------------	-------------------------	----	---	----------	----------

Zylinderdrehstangenschloss LAD Prestige 2000



9138588	4023149096112	für Schrankwand	ST	1	929,09	T&A 1148
----------------	---------------	-----------------	----	---	--------	----------

Schlossanbindung Stop Control



9078663	4023149120251	für beidseitige Verriegelung	ST	1	1.604,81	T&A 1207
----------------	---------------	------------------------------	----	---	----------	----------

Verriegelungsstangen Stop Control



0075547	4023149755477	7,5 HE	GN	1	709,00	T&A 1147
0077524	4023149775246	5,5 HE	ST	1	573,43	T&A 1147

Pro Decor Griffe

► Übersicht



ProDecor Griffe
Anzio

140



ProDecor Griffe
Narona

140



ProDecor Griffe
Hale

140 - 142



ProDecor Griffe
Salvia

142 - 144



ProDecor Griffe
Nicia

145 - 146



ProDecor Griffe
Vada

146



ProDecor Griffe
Avenio

147 - 149



ProDecor Griffe
Asopus

149 - 150



ProDecor Griffe
Befestigungsschrauben

150

Pro Decor Griffe

- ▶ Anzio
- ▶ Narona, Hale

	Kat-Nr	Händler/EAN	Artikelbeschreibung	ME	VPE	€ / 100*	Katalog / Seite
Griff Anzio, Edelstahl gebürstet							
	1160018	4023149900976	•-• 128 mm, L 138 mm	ST	1	646,16	PD 13
	1160019	4023149900983	•-• 160 mm, L 170 mm	ST	1	708,78	PD 13
	9204175	4023149229022	•-• 192 mm, L 202 mm	ST	1	744,42	PD 13
	1160023	4023149901034	•-• 480 mm, L 490 mm	ST	1	979,90	PD 13

	Kat-Nr	Händler/EAN	Artikelbeschreibung	ME	VPE	€ / 100*	Katalog / Seite
Griff Narona, Edelstahl gebürstet							
	9070970	4008057118682	•-• 96 mm, L 108 mm, ø 12 mm	ST	1	326,25	PD 16
	9070973	4008057118699	•-• 128 mm, L 140 mm, ø 12 mm	ST	1	353,09	PD 16
	9070975	4008057118705	•-• 160 mm, L 172 mm, ø 12 mm	ST	1	380,53	PD 16
	9070992	4008057118712	•-• 192 mm, L 204 mm, ø 12 mm	ST	1	412,88	PD 16
	9203963	4023149982934	•-• 224 mm, L 236 mm, ø 12 mm	ST	1	442,70	PD 16
	9070995	4008057118729	•-• 288 mm, L 300 mm, ø 12 mm	ST	1	497,32	PD 16
	9070998	4008057118736	•-• 320 mm, L 332 mm, ø 12 mm	ST	1	533,43	PD 16
	9070977	4008057118743	•-• 352 mm, L 364 mm, ø 12 mm	ST	1	575,29	PD 16
	9070979	4008057118750	•-• 384 mm, L 396 mm, ø 12 mm	ST	1	606,50	PD 16
	9071000	4008057118767	•-• 480 mm, L 492 mm, ø 12 mm	ST	1	705,99	PD 16
	9071010	4008057118774	•-• 640 mm, L 652 mm, ø 12 mm	ST	1	859,14	PD 16
	9071013	4008057118781	•-• 736 mm, L 748 mm, ø 12 mm	ST	1	930,92	PD 16

	Kat-Nr	Händler/EAN	Artikelbeschreibung	ME	VPE	€ / 100*	Katalog / Seite
Stangengriff Hale, Verchromt glanz							
	9070807	4008057119443	•-• 96 mm, L 156 mm, ø 12 mm	ST	1	185,81	PD 17
	9070809	4008057119467	•-• 128 mm, L 188 mm, ø 12 mm	ST	1	206,77	PD 17
	9070811	4008057119498	•-• 160 mm, L 220 mm, ø 12 mm	ST	1	231,40	PD 17
	9070817	4008057119528	•-• 192 mm, L 252 mm, ø 12 mm	ST	1	256,92	PD 17

Kat-Nr	Händler/EAN	Artikelbeschreibung	ME	VPE	€ / 100*	Katalog / Seite
9070821	4008057119559	•-• 224 mm, L 284 mm, ø 12 mm	ST	1	296,67	PD 17
9070813	4008057119580	•-• 288 mm, L 348 mm, ø 12 mm	ST	1	348,04	PD 17
9070825	4008057119610	•-• 352 mm, L 412 mm, ø 12 mm	ST	1	396,02	PD 17
9070803	4008057457170	•-• 448 mm, L 508 mm, ø 12 mm	ST	1	453,35	PD 17
9070816	4023149503573	•-• 480 mm, L 540 mm, ø 12 mm	ST	1	492,22	PD 17

Stangengriff Hale, Edelstahl Optik gebürstet





9070674	4008057119436	•-• 96 mm, L 156 mm, ø 12 mm	ST	1	135,86	PD 17
9070750	4008057770378	•-• 128 mm, L 188 mm, ø 12 mm	ST	1	147,00	PD 17
9070796	4008057119481	•-• 160 mm, L 220 mm, ø 12 mm	ST	1	165,61	PD 17
9070746	4008057457101	•-• 184 mm, L 244 mm, ø 12 mm	ST	1	181,70	PD 17
9070765	4008057119511	•-• 192 mm, L 252 mm, ø 12 mm	ST	1	187,20	PD 17
9070763	4008057119542	•-• 224 mm, L 284 mm, ø 12 mm	ST	1	208,86	PD 17
9070742	4008057457118	•-• 234 mm, L 294 mm, ø 12 mm	ST	1	216,92	PD 17
9070734	4008057457125	•-• 284 mm, L 344 mm, ø 12 mm	ST	1	237,11	PD 17
9070759	4008057119573	•-• 288 mm, L 348 mm, ø 12 mm	ST	1	254,88	PD 17
9070733	4008057457132	•-• 334 mm, L 394 mm, ø 12 mm	ST	1	267,44	PD 17
9070758	4008057119603	•-• 352 mm, L 412 mm, ø 12 mm	ST	1	293,71	PD 17
9070732	4008057457149	•-• 384 mm, L 444 mm, ø 12 mm	ST	1	300,08	PD 17
9070736	4008057457156	•-• 434 mm, L 494 mm, ø 12 mm	ST	1	335,27	PD 17
9070756	4008057457187	•-• 448 mm, L 508 mm, ø 12 mm	ST	1	358,60	PD 17



Unverbindliche Preisempfehlung. Preise gültig bei Abnahme von ganzen Verpackungseinheiten zzgl. MwSt.

Pro Decor Griffe



- ▶ Hale
- ▶ Salvia



	Kat-Nr	Händler/EAN	Artikelbeschreibung	ME	VPE	€ / 100*	Katalog / Seite
	9070753	4008057457217	•-• 480 mm, L 540 mm, ø 12 mm	ST	1	362,00	PD 17
	9070738	4008057457163	•-• 484 mm, L 544 mm, ø 12 mm	ST	1	367,46	PD 17
	9070743	4008057770439	•-• 784 mm, L 844 mm, ø 12 mm	ST	1	530,58	PD 17
	9070747	4008057770446	•-• 2 x 453,5 mm, L 987 mm, ø 12 mm	ST	1	691,47	PD 17
	9070751	4008057770453	•-• 2 x 540 mm, L 1140 mm, ø 12 mm	ST	1	806,14	PD 17
	9070755	4008057770460	•-• 2 x 620 mm, L 1300 mm, ø 12 mm	ST	1	921,57	PD 17
Stangengriff Salvia, ø 10 mm, Edelstahl gebürstet							
	9070967	4008057112055	•-• 96 mm, L 156 mm	ST	1	254,22	PD 18
	9070972	4008057112062	•-• 128 mm, L 188 mm	ST	1	277,52	PD 18
	9070978	4008057112079	•-• 160 mm, L 220 mm	ST	1	300,57	PD 18
	9070982	4008057112086	•-• 192 mm, L 252 mm	ST	1	324,10	PD 18
	9070984	4008057112093	•-• 224 mm, L 284 mm	ST	1	349,64	PD 18
	9070988	4008057112109	•-• 256 mm, L 316 mm	ST	1	372,94	PD 18
	9070991	4008057112116	•-• 288 mm, L 348 mm	ST	1	404,66	PD 18
	9070993	4008057112123	•-• 320 mm, L 380 mm	ST	1	430,98	PD 18
	9070996	4008057112130	•-• 352 mm, L 412 mm	ST	1	454,54	PD 18
	9070999	4008057112147	•-• 384 mm, L 444 mm	ST	1	477,84	PD 18

	Kat-Nr	Händler/EAN	Artikelbeschreibung	ME	VPE	€/ 100*	Katalog / Seite
Stangengriff Salvia, ø 12 mm, Edelstahl gebürstet							
	9071003	4008057112154	•-• 96 mm, L 157 mm	ST	1	318,90	PD 18
	9071005	4008057112161	•-• 128 mm, L 188 mm	ST	1	351,36	PD 18
	9071008	4008057112178	•-• 160 mm, L 220 mm	ST	1	383,48	PD 18
	9071009	4008057112185	•-• 192 mm, L 252 mm	ST	1	416,20	PD 18

Stangengriff Salvia, ø 12 mm, Edelstahl gebürstet							
	9071012	4008057112192	•-• 224 mm, L 284 mm	ST	1	454,57	PD 18
	9071017	4008057112208	•-• 256 mm, L 316 mm	ST	1	486,99	PD 18
	9071020	4008057112215	•-• 288 mm, L 348 mm	ST	1	524,13	PD 18
	9071021	4008057112222	•-• 320 mm, L 380 mm	ST	1	559,57	PD 18
	9071023	4008057112239	•-• 352 mm, L 412 mm	ST	1	592,25	PD 18
	9071024	4008057112246	•-• 384 mm, L 444 mm	ST	1	624,67	PD 18
	9071026	4008057112253	•-• 448 mm, L 508 mm	ST	1	689,52	PD 18
	9071027	4008057112260	•-• 480 mm, L 540 mm	ST	1	734,35	PD 18
	9071030	4008057112277	•-• 640 mm, L 700 mm	ST	1	907,69	PD 18
	9071038	4008057112284	•-• 736 mm, L 796 mm	ST	1	1.005,25	PD 18
	9071041	4008057112291	•-• 2 x 480 mm, L 1020 mm	ST	1	1.262,60	PD 18
	9071042	4008057112307	•-• 2 x 640 mm, L 1340 mm	ST	1	1.797,08	PD 18
	9071043	4008057112314	•-• 2 x 720 mm, L 1500 mm	ST	1	1.982,35	PD 18

Unverbindliche Preisempfehlung. Preise gültig bei Abnahme von ganzen Verpackungseinheiten zzgl. MwSt.



	Kat-Nr	Händler/EAN	Artikelbeschreibung	ME	VPE	€/ 100*	Katalog / Seite
Stangengriff Salvia, ø 14 mm, Edelstahl gebürstet							
	9071045	4008057112321	•-• 96 mm, L 158 mm	ST	1	384,10	PD 18
	9071046	4008057112338	•-• 128 mm, L 188 mm	ST	1	430,26	PD 18
	9071048	4008057112345	•-• 160 mm, L 220 mm	ST	1	470,44	PD 18
	9071050	4008057112352	•-• 192 mm, L 252 mm	ST	1	510,88	PD 18
	9071051	4008057112369	•-• 224 mm, L 284 mm	ST	1	562,06	PD 18
	9071052	4008057112376	•-• 256 mm, L 316 mm	ST	1	602,46	PD 18
	9071053	4008057112383	•-• 288 mm, L 348 mm	ST	1	636,12	PD 18
	9071054	4008057112390	•-• 320 mm, L 380 mm	ST	1	679,43	PD 18
	9071055	4008057112406	•-• 352 mm, L 412 mm	ST	1	719,91	PD 18
	9071056	4008057112413	•-• 384 mm, L 444 mm	ST	1	760,02	PD 18
	9071058	4008057112420	•-• 448 mm, L 508 mm	ST	1	841,45	PD 18
	9071111	4008057112437	•-• 480 mm, L 540 mm	ST	1	894,69	PD 18
	9071112	4008057112444	•-• 640 mm, L 700 mm	ST	1	1.106,30	PD 18
	9071115	4008057112451	•-• 736 mm, L 796 mm	ST	1	1.227,10	PD 18
	9071116	4008057112468	•-• 2 x 480 mm, L 1020 mm	ST	1	1.546,77	PD 18
	9071118	4008057112475	•-• 2 x 640 mm, L 1340 mm	ST	1	2.174,20	PD 18
	9071120	4008057112482	•-• 2 x 720 mm, L 1500 mm	ST	1	2.400,38	PD 18

	Kat-Nr	Händler/EAN	Artikelbeschreibung	ME	VPE	€/ 100*	Katalog / Seite
Griff Nicia, ø 10 mm, Verchromt glanz							
	9070983	4008057118873	•-• 96 mm, L 112 mm	ST	1	116,09	PD 63
	9071037	4008057752138	•-• 128 mm, L 148 mm	ST	1	116,57	PD 63
	9070997	4008057118941	•-• 160 mm, L 184 mm	ST	1	137,30	PD 63
	9071018	4008057119016	•-• 192 mm, L 221 mm	ST	1	177,99	PD 63
	9071049	4008057752244	•-• 224 mm, L 258 mm	ST	1	202,20	PD 63
Griff Nicia, ø 10 mm, Verchromt matt							
	9070986	4008057118903	•-• 96 mm, L 112 mm	ST	1	113,05	PD 63
	9071039	4008057752145	•-• 128 mm, L 148 mm	ST	1	110,76	PD 63
	9071001	4008057118972	•-• 160 mm, L 184 mm	ST	1	132,35	PD 63
	9070784	4008057119047	•-• 192 mm, L 221 mm	ST	1	173,04	PD 63
	9071063	4008057752251	•-• 224 mm, L 258 mm	ST	1	196,51	PD 63
Griff Nicia, ø 10 mm, Vernickelt matt							
	9071014	4008057118880	•-• 96 mm, L 112 mm	ST	1	113,05	PD 63
	9070976	4008057752121	•-• 128 mm, L 148 mm	ST	1	110,76	PD 63
	9071016	4008057118958	•-• 160 mm, L 184 mm	ST	1	132,35	PD 63
	9071019	4008057119023	•-• 192 mm, L 221 mm	ST	1	173,04	PD 63
	9070980	4008057752237	•-• 224 mm, L 258 mm	ST	1	196,51	PD 63

Pro Decor Griffe

► Nicia

► Vada

	Kat-Nr	Händler/EAN	Artikelbeschreibung	ME	VPE	€ / 100*	Katalog / Seite
Griff Nicia, ø 10 mm, Edelstahl gebürstet							
	9070985	4008057118897	•-• 96 mm, L 112 mm	ST	1	113,05	PD 63
	9071067	4008057765947	•-• 128 mm, L 148 mm	ST	1	110,77	PD 63
	9070722	4008057118965	•-• 160 mm, L 184 mm	ST	1	132,35	PD 63
	9070723	4008057119030	•-• 192 mm, L 221 mm	ST	1	173,04	PD 63
	9071068	4008057770590	•-• 224 mm, L 258 mm	ST	1	196,51	PD 63
Griff Vada, ø 10 mm, Edelstahl gebürstet							
	9070440	4008057119368	•-• 64 mm, L 75 mm	ST	1	166,66	PD 69
	9070446	4008057119375	•-• 96 mm, L 111 mm	ST	1	183,37	PD 69
	9070501	4008057742597	•-• 128 mm, L 149 mm	ST	1	211,24	PD 69
	9070451	4008057119382	•-• 160 mm, L 184 mm	ST	1	247,81	PD 69
	9070457	4008057119399	•-• 192 mm, L 222 mm	ST	1	288,45	PD 69
	9070504	4008057742603	•-• 224 mm, L 260 mm	ST	1	386,52	PD 69
	9070466	4008057119405	•-• 256 mm, L 297 mm	ST	1	495,98	PD 69
	9070509	4008057742610	•-• 288 mm, L 335 mm	ST	1	541,54	PD 69
	9070481	4008057119412	•-• 320 mm, L 368 mm	ST	1	613,04	PD 69
	9070494	4008057119429	•-• 352 mm, L 392 mm	ST	1	662,13	PD 69

	Kat-Nr	Händler/EAN	Artikelbeschreibung	ME	VPE	€/ 100*	Katalog / Seite
	9070605	4008057230346	•--• 64 mm, L 72 mm, ø 8 mm	ST	1	80,26	PD 70
	9070602	4008057230322	•--• 96 mm, L 104 mm, ø 8 mm	ST	1	92,32	PD 70
	9070075	4008057111478	•--• 128 mm, L 136 mm, ø 8 mm	ST	1	107,58	PD 70
	9070443	4008057111591	•--• 64 mm, L 74 mm, ø 10 mm	ST	1	97,98	PD 70
	9070519	4008057119696	•--• 96 mm, L 106 mm, ø 10 mm	ST	1	113,63	PD 70
	9070625	4008057307772	•--• 128 mm, L 138 mm, ø 10 mm	ST	1	132,44	PD 70
	9070548	4008057119795	•--• 160 mm, L 170 mm, ø 10 mm	ST	1	151,31	PD 70
	9069899	4008057119863	•--• 192 mm, L 202 mm, ø 10 mm	ST	1	169,10	PD 70
	9069922	4008057111287	•--• 288 mm, L 298 mm, ø 10 mm	ST	1	233,62	PD 70
	9069900	4008057230285	•--• 352 mm, L 362 mm, ø 10 mm	ST	1	281,69	PD 70

	Griff Avenio, Verchromt matt						
	Kat-Nr	Händler/EAN	Artikelbeschreibung	ME	VPE	€/ 100*	Katalog / Seite
	9069943	4008057111409	•--• 64 mm, L 72 mm, ø 8 mm	ST	1	78,10	PD 70
	9070054	4008057111447	•--• 96 mm, L 104 mm, ø 8 mm	ST	1	88,99	PD 70
	9070078	4008057111485	•--• 128 mm, L 136 mm, ø 8 mm	ST	1	101,83	PD 70
	9070521	4008057119702	•--• 96 mm, L 106 mm, ø 10 mm	ST	1	107,55	PD 70
	9070540	4008057119764	•--• 128 mm, L 138 mm, ø 10 mm	ST	1	124,16	PD 70
	9070552	4008057119801	•--• 160 mm, L 170 mm, ø 10 mm	ST	1	141,75	PD 70

Kat-Nr	Händler/EAN	Artikelbeschreibung	ME	VPE	€ / 100*	Katalog / Seite
9070572	4008057119870	•-• 192 mm, L 202 mm, ø 10 mm	ST	1	159,92	PD 70
9069877	4008057111294	•-• 288 mm, L 298 mm, ø 10 mm	ST	1	222,92	PD 70
9069892	4008057111355	•-• 352 mm, L 362 mm, ø 10 mm	ST	1	268,73	PD 70

Griff Avenio, Vernickelt matt



9069919	4008057530354	•-• 64 mm, L 72 mm, ø 8 mm	ST	1	78,10	PD 70
9069915	4008057230339	•-• 96 mm, L 104 mm, ø 8 mm	ST	1	88,99	PD 70
9069907	4008057111492	•-• 128 mm, L 136 mm, ø 8 mm	ST	1	101,83	PD 70
9070511	4008057111614	•-• 64 mm, L 74 mm, ø 10 mm	ST	1	93,59	PD 70
9070522	4008057119719	•-• 96 mm, L 106 mm, ø 8 mm	ST	1	107,55	PD 70
9070619	4008057307741	•-• 128 mm, L 138 mm, ø 10 mm	ST	1	124,16	PD 70
9069909	4008057119818	•-• 160 mm, L 170 mm, ø 10 mm	ST	1	141,75	PD 70
9069868	4008057119887	•-• 192 mm, L 202 mm, ø 10 mm	ST	1	159,92	PD 70
9069867	4008057111300	•-• 288 mm, L 298 mm, ø 10 mm	ST	1	222,92	PD 70
9069873	4008057230292	•-• 352 mm, L 362 mm, ø 10 mm	ST	1	268,73	PD 70

Griff Avenio, Edelstahl Optik gebürstet



9070512	4008057111621	•-• 64 mm, L 74 mm, ø 10 mm	ST	1	93,59	PD 70
9070527	4008057119726	•-• 96 mm, L 106 mm, ø 10 mm	ST	1	107,55	PD 70
9070448	4008057765930	•-• 128 mm, L 138 mm, ø 10 mm	ST	1	124,16	PD 70
9070557	4008057119825	•-• 160 mm, L 170 mm, ø 10 mm	ST	1	141,75	PD 70

Pro Decor Griffe

- ▶ Avenio
- ▶ Asopus

Kat-Nr	Händler/EAN	Artikelbeschreibung	ME	VPE	€/ 100*	Katalog / Seite
9070577	4008057119894	•--• 192 mm, L 202 mm, ø 10 mm	ST	1	159,92	PD 70
9069927	4008057111317	•--• 288 mm, L 298 mm, ø 10 mm	ST	1	222,92	PD 70
9070025	4008057111362	•--• 352 mm, L 362 mm, ø 10 mm	ST	1	268,73	PD 70

Griff Asopus, Edelstahl gebürstet



9070096	4008057111959	•--• 64 mm, L 72 mm, ø 8 mm	ST	1	125,58	PD 71
9069942	4008057111966	•--• 96 mm, L 104 mm, ø 8 mm	ST	1	144,08	PD 71
9070101	4008057111973	•--• 128 mm, L 136 mm, ø 8 mm	ST	1	162,31	PD 71
9069815	4008057742498	•--• 96 mm, L 106 mm, ø 10 mm	ST	50	183,45	PD 71
9069818	4008057742504	•--• 128 mm, L 138 mm, ø 10 mm	ST	1	197,92	PD 71
9070124	4008057111980	•--• 160 mm, L 170 mm, ø 10 mm	ST	1	240,28	PD 71
9070420	4008057111997	•--• 192 mm, L 202 mm, ø 10 mm	ST	1	271,83	PD 71
9069821	4008057742511	•--• 224 mm, L 234 mm, ø 10 mm	ST	1	317,11	PD 71
9069865	4008057742528	•--• 320 mm, L 330 mm, ø 10 mm	ST	1	416,30	PD 71
9070421	4008057112000	•--• 352 mm, L 362 mm, ø 10 mm	ST	1	444,49	PD 71
9070102	4008057112017	•--• 96 mm, L 108 mm, ø 12 mm	ST	1	264,04	PD 71
9070103	4008057112024	•--• 128 mm, L 140 mm, ø 12 mm	ST	1	293,07	PD 71
9070117	4008057742542	•--• 160 mm, L 172 mm, ø 12 mm	ST	1	333,61	PD 71
9070105	4008057112031	•--• 192 mm, L 204 mm, ø 12 mm	ST	1	371,85	PD 71
9070118	4008057742559	•--• 224 mm, L 236 mm, ø 12 mm	ST	1	440,89	PD 71

Unverbindliche Preisempfehlung. Preise gültig bei Abnahme von ganzen Verpackungseinheiten zzgl. MwSt.

Pro Decor Griffe

► Asopus

► Griff-Befestigungsschrauben

Kat-Nr	Händler/EAN	Artikelbeschreibung	ME	VPE	€ / 100*	Katalog / Seite
9070119	4008057742566	•-• 320 mm, L 332 mm, ø 12 mm	ST	1	572,04	PD 71
9070111	4008057112048	•-• 352 mm, L 364 mm, ø 12 mm	ST	1	607,38	PD 71
9070120	4008057742573	•-• 480 mm, L 492 mm, ø 12 mm	ST	1	827,13	PD 71
9070122	4008057742580	•-• 704 mm, L 716 mm, ø 12 mm	ST	1	1.184,56	PD 71

Griff-Befestigungsschrauben



0071549	4023149715495	M4 x 22 mm	ST	1	8,27	PD 112
0071555	4023149715556	M4 x 24 mm	ST	1	8,62	PD 112
0071556	4023149715563	M4 x 26 mm	ST	1	9,27	PD 112
0071558	4023149715587	M4 x 30 mm	ST	1	10,06	PD 112
0071563	4023149715631	M4 x 40 mm	ST	1	11,77	PD 112
0071856	4023149718564	M4 x 45 mm	ST	1	8,55	PD 112

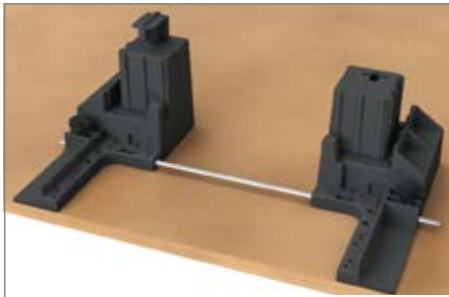

AvanFit 100 / ArciFit 100 für
AvanTech YOU /
ArciTech Schubkastensystem

153

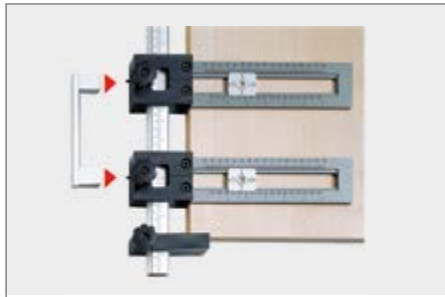

Accura Bohrlehre
und Zubehör

153



Exakta Bohrlehre

154



Practica Bohrlehre
und Zubehör

154



BlueJig ArciTech, Scharnier

154



Bohrlehre DrillJig, Scharniere

155



Bohrlehre DrillJig VB

155



BlueJig Dübel

155



Ankörnlehre BlueJig Griff

155



BlueJig Actro 5D

155









BlueJig Quadro EB 20 / Quadro 4D
BlueJig Quadro EB 1 Start

155











Stufenbohrer und Bohrer

156

	Kat-Nr	Händler/EAN	Artikelbeschreibung	ME	VPE	€ / 100*	Katalog / Seite
ArciFit 100							
	9123524	4023149095795	Zur Montage von ArciTech Schubkästen und Frontauszügen	ST	1	6.889,06	T&A 1023
AvanFit 100							
	9219678	4023149056376	Zur Montage von AvanTech YOU Schubkästen und Frontauszügen	ST	1	18.127,88	T&A 1021
Accura Schiene							
	0070263	4023149702631	Mit Maßskala, Länge 1000 mm	ST	1	5.498,67	T&A 1029
Accura							
	0070265	4023149702655	Bohrkörper für Führungssysteme, Aluminium / Kunststoff	ST	1	7.401,13	T&A 1029
	0070266	4023149702662	Verstellbarer Anschlag für einzelne (zerlegte) Korpusseiten, Kunststoff	ST	1	1.127,52	T&A 1029
	0070267	4023149702679	Verstellbarer Anschlag für montierten Korpus, Kunststoff	ST	1	1.078,48	T&A 1029
Korpusbohrlehre für Führungen							
	9257327	4023149178047	AVT YOU Führungsbohrlehre	ST	1	893,81	T&A 1032
Set Accura Bohrlehre							
	0044763	4023149447631	Für Griffe und Knöpfe	GN	1	25.966,13	T&A 1030
Accura Bohrbalken							
	0010573	4023149105739	1000 mm, Aluminium mit 3 Anschlag - / Absteckstiften	ST	1	13.213,00	T&A 1031

Verarbeitungshilfen

► Bohrlehren

	Kat-Nr	Händler/EAN	Artikelbeschreibung	ME	VPE	€ / 100*	Katalog / Seite
Exakta							
	0022617	4023149226175	Für Scharniere, Montageplatten, Verbindungsbeschläge und Bodenträger	ST	150	1.088,47	T&A 1034
Ankörn-Schablone							
	0000351	4008057003513	MultiBlue für Scharniere, Montageplatten, Verbindungsbeschläge und Bodenträger	ST	1	167,13	T&A 1035
Winkelanschlag							
	0078093	4023149780936	Zur Kombination mit Bohrlehre Practica	ST	1	13.992,05	T&A 1038
Practica für ArciTech							
	9257320	4023149177996	Zum Einbringen der Blendenbefestigung	ST	1	14.880,76	T&A 1038
Practica 250							
	9219328	4023149057342	für AvanTech YOU	ST	1	13.716,76	T&A 1039
	9257319	4023149177989	Zentrierbohrer Practica 250/200	ST	1	6.227,64	T&A 1070
Practica 265 für Aluminiumfronten							
	9254997	4023149180705	für AvanTech YOU	ST	1	16.156,26	T&A 1042
BlueJig AvanTech 105							
	9257323	4023149178009	Zum Ankörnen der Befestigungsbohrungen für AvanTech YOU Frontbefestigung, links / rechts	ST	1	2.487,11	T&A 1040
BlueJig AvanTech 205							
	9257324	4023149178016	für AvanTech YOU	Set	1	2.487,11	T&A 1040

Unverbindliche Preisempfehlung. Preise gültig bei Abnahme von ganzen Verpackungseinheiten zzgl. MwSt.

	Kat-Nr	Händler/EAN	Artikelbeschreibung	ME	VPE	€ / 100*	Katalog / Seite
Praktika 275 für AvanTech							
	9257321	4023149177958	für AvanTech YOU	ST	1	4.781,00	T&A 1042
Bohrlehre DrillJig Scharnier							
	0020165	4023149201653	Für die Montage von Scharnieren, Bohrer ø 35 mm / 2 x ø 10 mm	ST	1	25.239,82	T&A 1047
BlueJig Scharnier							
	0045150	4023149451508	Zum Ankörnen der Bohrpositionen von Scharnieren (TH 52) und Kreuzmontageplatten	ST	1	227,95	T&A 1048
Bohrlehre DrillJig VB							
	0020166	4023149201660	Für die Montage von Verbindungsbeschlägen, Bohrer ø 20 mm	ST	1	28.862,33	T&A 1054
BlueJig Dübel							
	9079402	4023149008177	Für stirnseitige Bohrungen zur Montage von Stahldübeln	ST	1	4.612,65	T&A 1055
Ankörnlehre BlueJig Griff							
	0048771	4023149487712	Für Griffe und Knöpfe	ST	1	1.287,41	T&A 1058
BlueJig Actro 5D							
	9257813	4023149181399	Zum Einbringen der Bohrung für den C-Haken	ST	1	7.420,38	T&A 1059
BlueJig Push to open Silent							
	9257326	4023149178030	Zum Einstellen des Blendenspalts bei Öffnungssystem Push to open Silent	ST	1	6.936,98	T&A 1059

Verarbeitungshilfen

- ▶ Bohrlehren
- ▶ Bohrer

	Kat-Nr	Händler/EAN	Artikelbeschreibung	ME	VPE	€ / 100*	Katalog / Seite
--	--------	-------------	---------------------	----	-----	----------	-----------------

BlueJig Quadro EB 20 / Quadro 4D



0044777	4023149990830	Zum Einbringen der Bohrung für den C-Haken	ST	1	16.773,87	T&A 1060
---------	---------------	--	----	---	-----------	----------

BlueJig Quadro EB 1 Start



9084515	4023149025587	Zum Einbringen der Bohrung für den C-Haken	ST	1	1.369,12	T&A 1060
---------	---------------	--	----	---	----------	----------

Stufenbohrer und Stelling



0019446	4023149194467	Stufenbohrer, ø 5 mm	ST	1	4.989,08	T&A 1068
---------	---------------	----------------------	----	---	----------	----------

0024838	4023149248382	Stelling	ST	1	507,33	T&A 1068
---------	---------------	----------	----	---	--------	----------

Bohrer



0070268	4023149702686	Hülzenbohrer, ø 5 mm	ST	1	8.207,21	T&A 1068
---------	---------------	----------------------	----	---	----------	----------

0070269	4023149702693	Ersatzbohrer ohne Hülse, ø 5 mm	ST	1	4.163,96	T&A 1068
---------	---------------	---------------------------------	----	---	----------	----------

0078096	4023149780967	Hülzenbohrer, ø 10 mm	ST	1	9.116,93	T&A 1068
---------	---------------	-----------------------	----	---	----------	----------

Bestellnummernverzeichnis

Kat-Nr.	BPL/Seite	Kat./Seite	VPE/ME	€/100*
0000351	153	T&A1035	1ST	167,13
0002809	132	T&A1117	1ST	211,38
0002813	132	T&A1117	1ST	156,41
0010067	27	T&A152	1ST	8,89
0010074	26	T&A140	1ST	111,66
0010573	152	T&A1031	1ST	13.213,00
0010921	34	T&A217	1GN	1.727,19
0013104	98	T&A750	1ST	38,74
0013116	95	T&A737	1ST	19,91
0013117	95	T&A737	1ST	4,68
0013121	96	T&A738	1ST	11,94
0013127	106	T&A811	1ST	9,96
0013138	105	T&A807	1ST	1,50
0013139	124	T&A723	1ST	38,97
0013140	124	T&A723	1ST	38,97
0013141	125	T&A723	1ST	49,34
0013142	125	T&A723	1ST	49,34
0013149	124	T&A722	1ST	387,46
0013153	124	T&A722	1ST	303,02
0013155	124	T&A722	1ST	407,41
0013157	124	T&A723	1ST	46,85
0013158	124	T&A723	1ST	46,85
0013233	35	T&A227	1ST	145,99
0013235	35	T&A227	1ST	159,18
0013907	110	T&A849	1ST	5.305,31
0013907	113	T&A849	1ST	5.305,31
0013908	110	T&A849	1ST	6.000,38
0013908	113	T&A849	1ST	6.000,38
0013909	113	T&A849	1ST	2.529,07
0013910	113	T&A849	1ST	3.097,41
0013952	75	T&A401	1ST	1.234,86
0013957	94	T&A730	1ST	9,28
0016048	98	T&A759	1ST	62,98
0016173	35	T&A226	1ST	1.077,63
0016174	35	T&A226	1ST	1.100,21
0016175	35	T&A226	1ST	1.120,56
0016180	104	T&A806	1ST	5,30
0016181	105	T&A808	1ST	6,00
0016190	101	T&A773	1ST	4,37
0019446	155	T&A1068	1ST	4.989,08
0019476	107	T&A834	1GN	493,57
0019556	100	T&A769	1ST	11,34
0019557	104	T&A806	1ST	11,16
0019558	99	T&A763	1ST	45,53
0019639	29	T&A178	1ST	287,01
0020018	103	T&A794	1ST	63,58
0020046	29	T&A179	1ST	748,65
0020056	94	T&A734	1ST	9,14
0020058	94	T&A734	1ST	9,14
0020060	95	T&A738	1ST	9,14
0020157	95	T&A734	1ST	9,14
0020165	154	T&A1047	1ST	25.239,82
0020166	154	T&A1054	1ST	28.862,33
0020532	129	T&A1092	1ST	2.362,10
0020571	131	T&A1101	1GN	454,50
0020576	131	T&A1112	1ST	4.193,36
0020592	137	T&A1167	1GN	503,02
0020711	128	T&A1080	1ST	19.910,31
0020722	129	T&A1092	1ST	2.056,12
0020782	105	T&A809	1ST	3,05
0020843	98	T&A750	1ST	95,66
0020864	35	T&A225	1ST	1.303,18

Kat-Nr.	BPL/Seite	Kat./Seite	VPE/ME	€/100*
0020873	27	T&A720	1ST	176,35
0020891	98	T&A750	1ST	95,66
0021575	35	T&A224	1ST	1.342,80
0021698	35	T&A224	1ST	1.342,80
0022617	153	T&A1034	1ST	1.088,47
0022737	105	T&A807	1ST	8,88
0023994	82	T&A487	1ST	454,08
0024832	99	T&A767	1ST	46,87
0024838	155	T&A1068	1ST	507,33
0024908	27	T&A160	1GN	1.370,37
0025048	21	T&A74	1ST	9,66
0025049	96	T&A740	1ST	109,72
0025052	96	T&A741	1ST	18,59
0025062	94	T&A730	1ST	9,17
0025064	94	T&A730	1ST	10,13
0025084	98	T&A759	1ST	54,12
0025090	104	T&A806	1ST	4,71
0025100	104	T&A806	1ST	11,25
0025120	84	T&A454	1ST	424,44
0025121	84	T&A454	1ST	424,44
0025124	105	T&A808	1ST	3,86
0025155	71	T&A381	1GN	505,57
0025156	71	T&A381	1GN	956,99
0025173	102	T&A782	1ST	810,07
0025174	102	T&A781	1ST	890,24
0025175	102	T&A781	1ST	752,29
0025182	102	T&A786	1ST	176,13
0025183	102	T&A787	1GN	589,35
0025189	102	T&A788	1ST	150,08
0025193	100	T&A768	1ST	34,37
0025194	100	T&A768	1ST	45,77
0025197	100	T&A768	1ST	44,37
0025204	21	T&A74	1ST	19,50
0025314	27	T&A160	1ST	580,28
0025660	84	T&A454	1ST	424,44
0026081	82	T&A477	1ST	1.672,71
0026082	82	T&A477	1ST	2.991,46
0026083	82	T&A477	1ST	4.710,34
0026561	71	T&A382	1GN	904,16
0026562	71	T&A382	1GN	977,47
0026578	71	T&A382	1GN	1.172,96
0030125	123	T&A712	1ST	33,38
0030765	71	T&A380	1GN	268,86
0030766	71	T&A380	1GN	318,28
0030767	71	T&A380	1GN	373,84
0030847	135	T&A1339	1ST	165,76
0030848	135	T&A1340	1ST	153,47
0030864	102	T&A778	1GN	1.998,36
0030866	27	T&A161	1GN	1.359,46
0031168	28	T&A174	1ST	302,80
0031169	28	T&A174	1ST	342,37
0031170	28	T&A174	1ST	526,26
0031571	104	T&A803	1ST	181,86
0040005	101	T&A770	1ST	4,17
0040007	99	T&A764	1ST	7,82
0040024	29	T&A184	1ST	625,88
0040279	116	T&A977	1ST	651,38
0040341	21	T&A135	1ST	173,20
0040438	104	T&A800	1ST	610,35
0040495	21	T&A135	1ST	211,68
0040669	107	T&A836	1ST	84,08
0040721	34	T&A217	1GN	1.702,16

Bestellnummernverzeichnis

Kat.-Nr.	BPL/Seite	Kat./Seite	VPE/ME	€/100*
0040722	33	T&A216	1GN	973,00
0041062	128	T&A1082	1ST	23.098,57
0041063	128	T&A1082	1ST	24.993,12
0041064	128	T&A1082	1ST	23.664,55
0041065	128	T&A1082	1ST	25.599,75
0041083	130	T&A1096	1GN	3.600,58
0041085	130	T&A1096	1GN	3.815,86
0041355	72	T&A385	1GN	2.131,52
0041357	73	T&A388	1GN	1.969,27
0041358	73	T&A388	1GN	2.166,20
0041359	73	T&A388	1GN	2.363,12
0041361	73	T&A388	1GN	2.560,05
0041362	73	T&A388	1GN	2.756,97
0041363	73	T&A388	1GN	3.003,13
0041364	73	T&A388	1GN	3.249,28
0041366	73	T&A388	1GN	3.790,84
0041394	73	T&A389	1GN	4.004,92
0041395	73	T&A389	1GN	4.140,69
0041396	73	T&A389	1GN	4.480,08
0041397	73	T&A389	1GN	4.819,48
0041398	73	T&A389	1GN	5.226,76
0041633	74	T&A398	1GN	2.206,47
0041635	74	T&A398	1GN	2.251,17
0041637	74	T&A398	1GN	2.306,75
0041639	74	T&A398	1GN	2.407,06
0041641	74	T&A398	1GN	2.507,35
0041643	75	T&A398	1GN	2.657,78
0041645	75	T&A398	1GN	2.858,39
0041647	75	T&A398	1GN	3.058,98
0041649	75	T&A398	1GN	3.309,70
0041651	75	T&A398	1GN	3.560,45
0041653	75	T&A398	1GN	3.861,33
0041655	75	T&A398	1GN	4.162,20
0041841	107	T&A841	1ST	25,41
0042339	28	T&A177	1ST	1.126,59
0042392	114	T&A962	1ST	5.480,33
0042393	114	T&A962	1ST	5.804,62
0042397	114	T&A962	1ST	6.161,34
0042462	114	T&A962	1ST	6.550,47
0042473	116	T&A991	1ST	860,00
0042474	116	T&A991	1ST	982,32
0042475	116	T&A991	1ST	1.041,86
0042507	115	T&A971	1ST	11.226,77
0044389	130	T&A1099	1ST	608,32
0044389	133	T&A1099	1ST	608,32
0044560	123	T&A706	1ST	188,59
0044565	123	T&A705	1ST	202,99
0044742	100	T&A767	1ST	57,03
0044743	100	T&A767	1ST	57,03
0044744	99	T&A766	1ST	140,79
0044747	103	T&A794	1ST	54,76
0044748	103	T&A794	1ST	54,76
0044750	94	T&A733	1ST	8,82
0044763	152	T&A1030	1ST	25.966,13
0044777	155	T&A1060	1ST	16.773,87
0044797	28	T&A176	1ST	1.741,09
0045026	33	T&A215	1ST	1.380,97
0045044	26	T&A142	1ST	506,91
0045045	26	T&A142	1ST	506,91
0045046	26	T&A140	1ST	553,96
0045047	26	T&A142	1ST	506,91
0045048	26	T&A140	1ST	577,46

Kat.-Nr.	BPL/Seite	Kat./Seite	VPE/ME	€/100*
0045063	26	T&A146	1ST	977,32
0045064	26	T&A148	1ST	648,03
0045065	26	T&A140	1ST	506,91
0045066	26	T&A140	1ST	577,46
0045067	26	T&A146	1ST	977,32
0045076	82	T&A487	1ST	7.298,33
0045077	82	T&A487	1ST	10.339,29
0045078	82	T&A487	1ST	12.772,07
0045079	82	T&A487	1ST	17.029,42
0045080	82	T&A464	1ST	2.123,43
0045081	82	T&A464	1ST	2.567,00
0045097	82	T&A487	1ST	16.455,42
0045150	154	T&A1048	1ST	227,95
0045169	20	T&A73	1GN	10,40
0045198	89	T&A591	1ST	1.986,98
0045234	85	T&A497	1ST	2.883,61
0045235	85	T&A497	1ST	4.269,08
0045284	68	T&A362	1GN	2.138,76
0045285	68	T&A362	1GN	2.121,60
0045286	68	T&A362	1GN	2.138,76
0045287	68	T&A362	1GN	2.164,54
0045288	68	T&A362	1GN	2.190,29
0045289	68	T&A362	1GN	2.207,44
0045290	68	T&A362	1GN	2.224,62
0045291	68	T&A362	1GN	2.250,38
0045292	68	T&A362	1GN	2.276,14
0045293	68	T&A362	1GN	2.293,31
0045294	68	T&A362	1GN	2.310,49
0045295	68	T&A362	1GN	2.370,58
0045296	68	T&A362	1GN	2.396,34
0045297	68	T&A362	1GN	2.413,52
0045307	111	T&A853	1GN	1.742,33
0045312	111	T&A853	1GN	1.742,33
0045317	81	T&A471	1ST	4.785,86
0045741	119	T&A667	1ST	1.165,59
0045861	135	T&A1337	1ST	1.846,08
0045871	135	T&A1337	1ST	2.371,58
0045968	136	T&A1242	1ST	102,00
0045969	136	T&A1242	1ST	136,87
0046049	134	T&A1300	1ST	5.194,10
0046080	99	T&A761	1ST	24,39
0046103	107	T&A839	1ST	32,80
0046287	124	T&A721	1ST	1.400,98
0046291	124	T&A721	1ST	2.690,41
0046294	124	T&A721	1ST	911,32
0046414	132	T&A1115	1ST	710,10
0046416	83	T&A477	1ST	3.105,43
0046417	83	T&A477	1ST	7.156,02
0046419	82	T&A464	1ST	10.733,48
0046642	105	T&A807	1ST	1,95
0046695	21	T&A74	1ST	6,54
0046700	101	T&A773	1ST	22,67
0046744	128	T&A1083	1ST	21.489,02
0046746	128	T&A1083	1ST	23.474,35
0046748	128	T&A1083	1ST	22.119,71
0046751	128	T&A1083	1ST	24.168,24
0046787	27	T&A163	1ST	1.279,10
0046787	89	T&A163	1ST	1.279,10
0046788	85	T&A497	1ST	8.795,91
0046849	29	T&A183	1GN	1.623,08
0047451	101	T&A772	1ST	5,17
0047452	101	T&A772	1ST	6,95

Unverbindliche Preisempfehlung. Preise gültig bei Abnahme von ganzen Verpackungseinheiten zzgl. MwSt.

Bestellnummernverzeichnis

Kat-Nr.	BPL/Seite	Kat./Seite	VPE/ME	€/100*
0047454	96	T&A740	1ST	124,53
0047458	94	T&A733	1ST	9,16
0047584	96	T&A741	1ST	4,70
0047609	105	T&A808	1ST	26,23
0047612	106	T&A811	1ST	903,74
0047615	115	T&A973	1ST	875,90
0047616	115	T&A973	1ST	2.216,53
0047632	102	T&A787	1ST	237,25
0047633	102	T&A786	1ST	292,52
0047634	102	T&A789	1ST	432,95
0047635	102	T&A789	1ST	320,05
0047637	90	T&A802	1ST	42,11
0047638	90	T&A802	1ST	51,11
0047639	90	T&A802	1ST	52,74
0047640	90	T&A802	1ST	59,57
0047642	90	T&A802	1ST	65,22
0047643	90	T&A802	1ST	9,14
0047645	90	T&A802	1ST	24,12
0047646	104	T&A803	1ST	198,22
0047654	103	T&A795	1ST	52,76
0047655	103	T&A795	1ST	52,76
0047661	106	T&A812	1ST	290,97
0047914	135	T&A1339	1ST	243,39
0047915	135	T&A1340	1ST	225,37
0048037	94	T&A733	1ST	8,15
0048038	94	T&A733	1ST	8,47
0048049	20	.	1ST	136,63
0048051	20	.	1ST	153,55
0048052	20	.	1ST	157,46
0048053	20	.	1ST	153,41
0048054	20	.	1ST	170,34
0048055	20	.	1ST	174,26
0048059	20	.	1ST	166,02
0048061	20	.	1ST	182,93
0048062	20	.	1ST	186,84
0048306	134	T&A1313	1ST	15.446,87
0048428	137	T&A1198	1ST	384,27
0048578	101	T&A771	1ST	14,02
0048586	101	T&A774	1ST	2,09
0048588	101	T&A774	1ST	2,09
0048590	101	T&A774	1ST	2,09
0048596	123	T&A705	1ST	118,23
0048679	112	T&A871	1ST	14.922,92
0048771	154	T&A1058	1ST	1.287,41
0049234	113	T&A876	1ST	5.849,25
0050314	99	T&A767	1ST	44,15
0051264	75	T&A772	1ST	6,70
0051265	42	T&A263	1ST	4,90
0052996	101	T&A773	1ST	7,41
0053012	105	T&A807	1ST	17,21
0056014	138	T&A1211	1GN	2.191,14
0056614	99	T&A764	1ST	103,73
0058588	135	T&A1339	1ST	165,76
0058590	135	T&A1339	1ST	241,58
0058797	123	T&A711	1ST	53,55
0060576	22	.	1ST	347,37
0060579	22	.	1ST	408,01
0061546	84	T&A454	1ST	424,44
0061851	103	T&A794	1ST	53,98
0061852	103	T&A794	1ST	56,72
0061853	103	T&A794	1ST	59,47
0061854	103	T&A795	1ST	30,96

Kat-Nr.	BPL/Seite	Kat./Seite	VPE/ME	€/100*
0061855	103	T&A797	1ST	14,56
0063016	101	T&A769	1ST	17,94
0063549	105	T&A810	1ST	3,94
0063598	106	T&A813	1ST	283,02
0064872	97	T&A746	1ST	18,59
0064908	101	T&A769	1ST	17,94
0065370	97	T&A747	1ST	18,59
0065480	107	T&A839	1ST	36,82
0065505	97	T&A742	1ST	42,66
0065507	97	T&A742	1ST	22,86
0065513	97	T&A743	1ST	43,52
0065515	97	T&A743	1ST	22,86
0065521	97	T&A744	1ST	57,97
0065523	97	T&A744	1ST	29,92
0065529	97	T&A745	1ST	57,97
0065531	97	T&A745	1ST	29,92
0065536	98	T&A747	1ST	55,75
0065540	97	T&A746	1ST	18,59
0066065	70	T&A368	1GN	2.520,88
0066075	70	T&A368	1GN	2.096,30
0066079	70	T&A368	1GN	1.910,56
0066900	84	T&A454	1ST	424,44
0066933	71	T&A380	1GN	273,01
0069603	25	T&A134	1ST	747,75
0069609	25	T&A134	1ST	669,71
0069933	29	T&A181	1ST	339,40
0069934	27	T&A160	1ST	1.130,37
0070135	134	T&A1296	1ST	7.284,03
0070144	134	T&A1296	1ST	11.629,55
0070151	103	T&A794	1ST	53,38
0070152	103	T&A794	1ST	54,12
0070153	103	T&A794	1ST	63,59
0070263	152	T&A1029	1ST	5.498,67
0070265	152	T&A1029	1ST	7.401,13
0070266	152	T&A1029	1ST	1.127,52
0070267	152	T&A1029	1ST	1.078,48
0070268	155	T&A1068	1ST	8.207,21
0070269	155	T&A1068	1ST	4.163,96
0070664	115	T&A974	1ST	31,49
0070666	115	T&A974	1ST	36,68
0070668	115	T&A975	1ST	65,65
0070676	115	T&A975	1ST	101,12
0070690	114	T&A966	1ST	5.444,43
0070692	114	T&A966	1ST	5.707,10
0070712	21	T&A135	1ST	163,57
0070713	21	T&A135	1ST	202,07
0070961	84	T&A454	1ST	1.573,44
0070983	89	T&A575	1ST	6.681,58
0070984	89	T&A575	1ST	6.681,58
0071054	94	T&A731	1ST	2,39
0071110	85	T&A497	1ST	4.397,95
0071113	82	T&A487	1ST	8.227,71
0071117	82	T&A464	1ST	5.368,04
0071549	150	PD112	1ST	8,27
0071555	150	PD112	1ST	8,62
0071556	150	PD112	1ST	9,27
0071558	150	PD112	1ST	10,06
0071563	150	PD112	1ST	11,77
0071648	27	T&A165	1ST	374,42
0071835	71	T&A380	1GN	281,23
0071836	71	T&A380	1GN	297,67
0071844	103	T&A795	1ST	33,04

Bestellnummernverzeichnis

Kat-Nr.	BPL/Seite	Kat./Seite	VPE/ME	€/100*
0071856	150	PD112	1ST	8,55
0071870	90	T&A802	1ST	49,82
0071925	20	T&A73	1ST	4,45
0071950	94	T&A730	1ST	11,64
0072120	21	T&A74	1ST	7,14
0072134	28	T&A170	1ST	839,31
0072213	122	T&A702	1ST	422,63
0072214	122	T&A702	1ST	422,63
0072217	122	T&A702	1ST	422,63
0072251	123	T&A709	1ST	183,40
0072253	123	T&A709	1ST	277,84
0072266	123	T&A709	1ST	129,66
0072267	123	T&A709	1ST	129,66
0072274	123	T&A709	1ST	63,97
0072300	119	T&A666	1ST	642,02
0072501	119	T&A665	1ST	1.104,30
0072502	118	T&A664	1ST	635,62
0072509	122	T&A698	1ST	598,08
0072687	119	T&A669	1ST	681,44
0072959	21	T&A190	1ST	266,77
0072960	21	T&A192	1ST	266,77
0072965	21	T&A190	1ST	283,67
0072966	21	T&A190	1ST	287,58
0072968	21	T&A192	1ST	287,58
0073276	72	T&A385	1GN	891,38
0073277	72	T&A385	1GN	995,08
0073278	72	T&A385	1GN	1.106,76
0073279	72	T&A385	1GN	1.211,50
0073280	72	T&A385	1GN	1.321,50
0073281	72	T&A385	1GN	1.425,82
0073282	72	T&A385	1GN	1.550,52
0073283	72	T&A385	1GN	1.890,13
0073284	72	T&A385	1GN	1.984,87
0073457	94	T&A730	1ST	9,64
0073460	94	T&A730	1ST	11,09
0073481	103	T&A797	1ST	17,70
0073564	113	T&A849	1ST	2.290,35
0073565	113	T&A849	1ST	2.729,16
0073596	114	T&A962	1ST	950,09
0073619	98	T&A748	1ST	57,01
0073747	135	T&A1339	1ST	162,59
0073748	135	T&A1339	1ST	221,08
0073925	20	T&A186	1ST	527,01
0073926	20	T&A186	1ST	547,85
0073927	20	T&A186	1ST	543,93
0074667	103	T&A796	1ST	63,07
0074688	97	T&A746	1ST	18,59
0074805	105	T&A810	1ST	34,41
0074862	129	T&A1090	1GN	1.348,43
0074863	130	T&A1095	1GN	1.143,27
0074864	130	T&A1095	1GN	1.262,05
0074865	130	T&A1097	1GN	3.708,59
0074866	130	T&A1097	1GN	3.930,33
0074879	129	T&A1125	1ST	970,52
0075498	131	T&A1112	1ST	4.071,22
0075547	138	T&A1147	1GN	709,00
0075554	131	T&A1101	1GN	432,84
0075555	137	T&A1167	1GN	488,38
0075572	132	T&A1115	1ST	291,08
0075808	70	T&A363	1GN	136,24
0076222	101	T&A773	1ST	8,26
0076470	85	T&A505	1ST	15.873,05

Kat-Nr.	BPL/Seite	Kat./Seite	VPE/ME	€/100*
0076471	85	T&A503	1ST	12.525,13
0076472	85	T&A503	1ST	828,79
0076474	85	T&A503	1ST	2.040,52
0076475	85	T&A505	1ST	275,74
0076476	85	T&A505	1ST	10.742,70
0076478	86	T&A505	1ST	6.814,06
0076480	86	T&A504	1ST	295,79
0076481	86	T&A504	1ST	1.123,21
0076482	86	T&A504	1ST	1.729,68
0076483	86	T&A504	1ST	4.430,15
0077524	138	T&A1147	1GN	573,43
0077602	128	T&A1080	1ST	19.352,07
0077734	26	T&A140	1ST	119,24
0077735	26	T&A140	1ST	132,22
0077736	26	T&A140	1ST	119,24
0077800	134	T&A1315	1GN	2.477,12
0077801	134	T&A1315	1GN	2.617,34
0077802	134	T&A1315	1GN	3.037,96
0077883	123	T&A702	1ST	936,00
0077884	123	T&A702	1ST	936,00
0077887	26	T&A140	1ST	132,22
0077892	119	T&A668	1ST	1.605,02
0077894	119	T&A666	1ST	702,39
0077942	26	T&A140	1ST	136,75
0078020	119	T&A664	1ST	1.337,33
0078093	153	T&A1038	1ST	13.992,05
0078096	155	T&A380	1ST	9.116,93
0079056	71	T&A380	1GN	384,74
0079386	98	T&A759	1ST	60,17
0079389	34	T&A217	1GN	1.473,58
0079397	33	T&A216	1GN	958,35
0079438	75	T&A400	1ST	13,07
0079438	99	T&A400	1ST	13,07
0079471	94	T&A730	1ST	9,23
0079472	94	T&A730	1ST	8,76
0079521	95	T&A734	1ST	12,76
0079525	100	T&A769	1ST	4,99
0079529	101	T&A770	1ST	6,16
0079540	99	T&A770	1ST	4,27
0079554	95	T&A735	1ST	44,11
0079568	95	T&A735	1ST	47,81
0079580	95	T&A736	1ST	67,05
0079659	100	T&A769	1ST	17,94
0079660	100	T&A769	1ST	21,09
0079664	99	T&A766	1ST	44,99
0079665	100	T&A238	1ST	46,86
0079665	39	T&A238	1ST	46,86
0079666	99	T&A766	1ST	37,04
0079689	103	T&A796	1ST	52,76
0079690	104	T&A797	1ST	41,17
0079707	105	T&A807	1ST	17,10
0079709	105	T&A809	1ST	4,68
0079710	105	T&A809	1ST	6,23
0079713	106	T&A812	1ST	281,79
0079714	106	T&A813	1ST	270,53
0079716	106	T&A824	1GN	543,11
0079717	106	T&A828	1GN	607,39
0079719	106	T&A826	1ST	4,38
0079724	106	T&A830	1GN	330,08
0079736	118	T&A663	1ST	990,01
0115365	89	T&A587	1ST	294,84
0115366	89	T&A587	1ST	301,27

Unverbindliche Preisempfehlung. Preise gültig bei Abnahme von ganzen Verpackungseinheiten zzgl. MwSt.

Bestellnummernverzeichnis

Kat.-Nr.	BPL/Seite	Kat./Seite	VPE/ME	€/100*
1040519	131	T&A1106	1ST	534,83
1041576	131	T&A1106	1ST	245,44
1041577	129	T&A1089	1ST	199,12
1041577	133	T&A1089	1ST	199,12
1051428	136	T&A1160	1ST	4.154,13
1051431	137	T&A1170	1ST	5.259,17
1054134	137	T&A1162	1ST	6.053,81
1054417	136	T&A1160	1ST	4.719,62
1055525	130	T&A1099	1ST	179,73
1055525	133	T&A1099	1ST	179,73
1058345	74	T&A397	1GN	342,68
1058346	74	T&A397	1GN	357,57
1058347	74	T&A397	1GN	372,46
1058348	74	T&A397	1GN	394,82
1058349	74	T&A397	1GN	424,62
1058350	74	T&A397	1GN	454,40
1065664	138	T&A1172	1ST	6.430,78
1065665	138	T&A1172	1ST	7.347,34
1079061	128	T&A1088	1ST	655,52
1079090	84	T&A454	1ST	1.431,70
1160018	140	PD13	1ST	646,16
1160019	140	PD13	1ST	708,78
1160023	140	PD13	1ST	979,90
9000894	115	T&A973	1ST	1.407,24
9004472	129	T&A1089	1ST	199,12
9004472	133	T&A1089	1ST	199,12
9007183	128	T&A1088	1ST	675,11
9007199	131	T&A1106	1ST	561,58
9007204	131	T&A1106	1ST	252,79
9007214	136	T&A1160	1ST	4.361,84
9007215	137	T&A1162	1ST	6.356,49
9007651	107	T&A838	1ST	1.471,59
9011908	136	T&A1160	1ST	4.955,60
9011942	137	T&A1170	1ST	5.522,13
9011947	138	T&A1172	1ST	6.752,31
9011948	138	T&A1172	1ST	7.714,72
9039362	136	T&A1111	1ST	327,43
9039372	136	T&A1111	1ST	337,24
9039373	137	T&A1198	1ST	373,09
9039921	131	T&A1111	1ST	1.901,70
9039923	131	T&A1111	1ST	1.996,77
9039924	131	T&A1111	1ST	1.630,04
9039927	131	T&A1111	1ST	1.711,54
9040230	81	T&A471	1ST	2.343,83
9047289	110	T&A851	1ST	777,31
9047290	110	T&A851	1ST	777,31
9047452	110	T&A851	1ST	777,31
9047453	110	T&A851	1ST	777,31
9051925	25	.	1ST	369,29
9061151	129	T&A1092	1ST	2.249,60
9061152	129	T&A1092	1ST	1.958,21
9065669	132	T&A1088	1ST	834,15
9065857	110	T&A852	1ST	7.639,46
9065860	111	T&A853	1ST	8.278,58
9065861	110	T&A852	1ST	788,36
9065862	111	T&A853	1ST	1.019,32
9069815	149	PD71	1ST	183,45
9069818	149	PD71	1ST	197,92
9069821	149	PD71	1ST	317,11
9069865	149	PD71	1ST	416,30
9069867	148	PD70	1ST	222,92
9069868	148	PD70	1ST	159,92

Kat.-Nr.	BPL/Seite	Kat./Seite	VPE/ME	€/100*
9069873	148	PD70	1ST	268,73
9069877	148	PD70	1ST	222,92
9069892	148	PD70	1ST	268,73
9069899	147	PD70	1ST	169,10
9069900	147	PD70	1ST	281,69
9069907	148	PD70	1ST	101,83
9069909	148	PD70	1ST	141,75
9069915	148	PD70	1ST	88,99
9069919	148	PD70	1ST	78,10
9069922	147	PD70	1ST	233,62
9069927	149	PD70	1ST	222,92
9069942	149	PD71	1ST	144,08
9069943	147	PD70	1ST	78,10
9070025	149	PD70	1ST	268,73
9070054	147	PD70	1ST	88,99
9070075	147	PD70	1ST	107,58
9070078	147	PD70	1ST	101,83
9070096	149	PD71	1ST	125,58
9070101	149	PD71	1ST	162,31
9070102	149	PD71	1ST	264,04
9070103	149	PD71	1ST	293,07
9070105	149	PD71	1ST	371,85
9070111	150	PD71	1ST	607,38
9070117	149	PD71	1ST	333,61
9070118	149	PD71	1ST	440,89
9070119	150	PD71	1ST	572,04
9070120	150	PD71	1ST	827,13
9070122	150	PD71	1ST	1.184,56
9070124	149	PD71	1ST	240,28
9070420	149	PD71	1ST	271,83
9070421	149	PD71	1ST	444,49
9070440	146	PD69	1ST	166,66
9070443	147	PD70	1ST	97,98
9070446	146	PD69	1ST	183,37
9070448	148	PD70	1ST	124,16
9070451	146	PD69	1ST	247,81
9070457	146	PD69	1ST	288,45
9070466	146	PD69	1ST	495,98
9070481	146	PD69	1ST	613,04
9070494	146	PD69	1ST	662,13
9070501	146	PD69	1ST	211,24
9070504	146	PD69	1ST	386,52
9070509	146	PD69	1ST	541,54
9070511	148	PD70	1ST	93,59
9070512	148	PD70	1ST	93,59
9070519	147	PD70	1ST	113,63
9070521	147	PD70	1ST	107,55
9070522	148	PD70	1ST	107,55
9070527	148	PD70	1ST	107,55
9070540	147	PD70	1ST	124,16
9070548	147	PD70	1ST	151,31
9070552	147	PD70	1ST	141,75
9070557	148	PD70	1ST	141,75
9070572	148	PD70	1ST	159,92
9070577	149	PD70	1ST	159,92
9070602	147	PD70	1ST	92,32
9070605	147	PD70	1ST	80,26
9070619	148	PD70	1ST	124,16
9070625	147	PD70	1ST	132,44
9070674	141	PD17	1ST	135,86
9070722	146	PD63	1ST	132,35
9070723	146	PD63	1ST	173,04

Bestellnummernverzeichnis

Kat-Nr.	BPL/Seite	Kat./Seite	VPE/ME	€/100*
9070732	141	PD17	1ST	300,08
9070733	141	PD17	1ST	267,44
9070734	141	PD17	1ST	237,11
9070736	141	PD17	1ST	335,27
9070738	142	PD17	1ST	367,46
9070742	141	PD17	1ST	216,92
9070743	142	PD17	1ST	530,58
9070746	141	PD17	1ST	181,70
9070747	142	PD17	1ST	691,47
9070750	141	PD17	1ST	147,00
9070751	142	PD17	1ST	806,14
9070753	142	PD17	1ST	362,00
9070755	142	PD17	1ST	921,57
9070756	141	PD17	1ST	358,60
9070758	141	PD17	1ST	293,71
9070759	141	PD17	1ST	254,88
9070763	141	PD17	1ST	208,86
9070765	141	PD17	1ST	187,20
9070784	145	PD63	1ST	173,04
9070796	141	PD17	1ST	165,61
9070803	141	PD17	1ST	453,35
9070807	140	PD17	1ST	185,81
9070809	140	PD17	1ST	206,77
9070811	140	PD17	1ST	231,40
9070813	141	PD17	1ST	348,04
9070816	141	PD17	1ST	492,22
9070817	140	PD17	1ST	256,92
9070821	140	PD17	1ST	296,67
9070825	141	PD17	1ST	396,02
9070967	142	PD18	1ST	254,22
9070970	140	PD16	1ST	326,25
9070972	142	PD18	1ST	277,52
9070973	140	PD16	1ST	353,09
9070975	140	PD16	1ST	380,53
9070976	145	PD63	1ST	110,76
9070977	140	PD16	1ST	575,29
9070978	142	PD18	1ST	300,57
9070979	140	PD16	1ST	606,50
9070980	145	PD63	1ST	196,51
9070982	142	PD18	1ST	324,10
9070983	145	PD63	1ST	116,09
9070984	142	PD18	1ST	349,64
9070985	146	PD63	1ST	113,05
9070986	145	PD63	1ST	113,05
9070988	142	PD18	1ST	372,94
9070991	142	PD18	1ST	404,66
9070992	140	PD16	1ST	412,88
9070993	142	PD18	1ST	430,98
9070995	140	PD16	1ST	497,32
9070996	142	PD18	1ST	454,54
9070997	145	PD63	1ST	137,30
9070998	140	PD16	1ST	533,43
9070999	142	PD18	1ST	477,84
9071000	140	PD16	1ST	705,99
9071001	145	PD63	1ST	132,35
9071003	143	PD18	1ST	318,90
9071005	143	PD18	1ST	351,36
9071008	143	PD18	1ST	383,48
9071009	143	PD18	1ST	416,20
9071010	140	PD16	1ST	859,14
9071012	143	PD18	1ST	454,57
9071013	140	PD16	1ST	930,92

Kat-Nr.	BPL/Seite	Kat./Seite	VPE/ME	€/100*
9071014	145	PD63	1ST	113,05
9071016	145	PD63	1ST	132,35
9071017	143	PD18	1ST	486,99
9071018	145	PD63	1ST	177,99
9071019	145	PD63	1ST	173,04
9071020	143	PD18	1ST	524,13
9071021	143	PD18	1ST	559,57
9071023	143	PD18	1ST	592,25
9071024	143	PD18	1ST	624,67
9071026	143	PD18	1ST	689,52
9071027	143	PD18	1ST	734,35
9071030	143	PD18	1ST	907,69
9071037	145	PD63	1ST	116,57
9071038	143	PD18	1ST	1.005,25
9071039	145	PD63	1ST	110,76
9071041	143	PD18	1ST	1.262,60
9071042	143	PD18	1ST	1.797,08
9071043	143	PD18	1ST	1.982,35
9071045	144	PD18	1ST	384,10
9071046	144	PD18	1ST	430,26
9071048	144	PD18	1ST	470,44
9071049	145	PD63	1ST	202,20
9071050	144	PD18	1ST	510,88
9071051	144	PD18	1ST	562,06
9071052	144	PD18	1ST	602,46
9071053	144	PD18	1ST	636,12
9071054	144	PD18	1ST	679,43
9071055	144	PD18	1ST	719,91
9071056	144	PD18	1ST	760,02
9071058	144	PD18	1ST	841,45
9071063	145	PD63	1ST	196,51
9071067	146	PD63	1ST	110,77
9071068	146	PD63	1ST	196,51
9071111	144	PD18	1ST	894,69
9071112	144	PD18	1ST	1.106,30
9071115	144	PD18	1ST	1.227,10
9071116	144	PD18	1ST	1.546,77
9071118	144	PD18	1ST	2.174,20
9071120	144	PD18	1ST	2.400,38
9072533	18	T&A69	1ST	94,19
9072534	18	T&A69	1ST	101,45
9072535	18	T&A69	1ST	108,69
9072536	18	T&A69	1ST	123,19
9072537	18	T&A68	1ST	123,19
9072540	19	T&A71	1ST	11,34
9072541	19	T&A72	1ST	11,34
9072548	28	T&A173	1ST	540,83
9073605	12	T&A26	1ST	302,57
9073605	89	T&A26	1ST	302,57
9073606	12	T&A26	1ST	321,34
9073607	12	T&A26	1ST	340,12
9073611	12	T&A26	1ST	333,05
9073612	12	T&A26	1ST	351,83
9073613	12	T&A26	1ST	370,61
9073614	12	T&A26	1ST	356,33
9073615	12	T&A26	1ST	375,11
9073616	12	T&A26	1ST	393,88
9073638	13	T&A26	1ST	219,10
9073639	13	T&A26	1ST	237,88
9073640	13	T&A26	1ST	256,64
9073644	13	T&A26	1ST	272,87
9073645	13	T&A26	1ST	291,65

Unverbindliche Preisempfehlung. Preise gültig bei Abnahme von ganzen Verpackungseinheiten zzgl. MwSt.

Bestellnummernverzeichnis

Kat.-Nr.	BPL/Seite	Kat./Seite	VPE/ME	€/100*
9073646	13	T&A26	1ST	310,43
9073662	13	T&A26	1ST	239,96
9073662	89	T&A26	1ST	239,96
9073663	13	T&A26	1ST	258,74
9073664	13	T&A26	1ST	277,53
9073668	13	T&A26	1ST	293,73
9073669	13	T&A26	1ST	312,52
9073670	13	T&A26	1ST	331,30
9075005	16	T&A62	1ST	33,65
9075006	16	T&A62	1ST	33,65
9075055	16	T&A62	1ST	35,25
9075056	16	T&A62	1ST	35,25
9075057	16	T&A62	1ST	41,66
9075058	16	T&A62	1ST	56,08
9075060	17	T&A64	1ST	67,28
9075061	17	T&A64	1ST	67,28
9075062	17	T&A64	1ST	73,69
9075063	17	T&A64	1ST	88,11
9075065	18	T&A64	1ST	67,28
9075066	18	T&A64	1ST	67,28
9075067	18	T&A64	1ST	73,69
9075068	18	T&A64	1ST	88,11
9075070	17	T&A63	1ST	67,28
9075071	17	T&A63	1ST	67,28
9075071	89	T&A63	1ST	67,28
9075072	17	T&A63	1ST	73,69
9075073	17	T&A63	1ST	88,11
9075080	17	T&A63	1ST	66,48
9075081	17	T&A63	1ST	66,48
9075082	17	T&A63	1ST	72,89
9075083	17	T&A63	1ST	87,31
9075085	17	T&A63	1ST	67,28
9075086	17	T&A63	1ST	67,28
9075087	17	T&A63	1ST	73,69
9075088	17	T&A63	1ST	88,11
9077588	110	T&A851	1ST	7.252,89
9077601	110	T&A851	1ST	411,54
9078219	138	T&A1194	1GN	2.441,14
9078227	138	T&A1194	1GN	2.563,18
9078512	132	T&A1117	1ST	1.002,90
9078515	132	T&A1117	1ST	1.079,68
9078539	132	T&A1116	1ST	255,09
9078565	129	T&A1090	1GN	2.166,11
9078663	138	T&A1207	1ST	1.604,81
9078681	136	T&A1163	1GN	4.715,90
9078694	136	T&A1163	1GN	4.779,76
9078709	136	T&A1165	1GN	638,73
9078710	136	T&A1165	1GN	702,58
9078711	137	T&A1165	1GN	1.961,77
9078712	137	T&A1165	1GN	2.025,66
9078717	137	T&A1173	1GN	5.772,93
9078719	137	T&A1173	1GN	5.836,80
9078795	134	T&A1314	1ST	5.346,71
9078797	134	T&A1312	1ST	14.825,92
9078860	120	T&A693	1ST	517,15
9078861	120	T&A693	1ST	517,15
9078862	121	T&A693	1ST	517,15
9078865	121	T&A693	1ST	517,15
9078867	121	T&A693	1ST	517,15
9078871	121	T&A693	1ST	517,15
9078874	121	T&A693	1ST	517,15
9078877	121	T&A693	1ST	517,15

Kat.-Nr.	BPL/Seite	Kat./Seite	VPE/ME	€/100*
9078878	121	T&A693	1ST	517,15
9078886	121	T&A693	1ST	517,15
9078888	121	T&A693	1ST	517,15
9078890	121	T&A693	1ST	517,15
9078894	121	T&A693	1ST	517,15
9078899	121	T&A693	1ST	517,15
9078902	121	T&A693	1ST	517,15
9078904	121	T&A693	1ST	517,15
9078911	121	T&A693	1ST	517,15
9078912	121	T&A693	1ST	517,15
9078915	121	T&A693	1ST	517,15
9078917	121	T&A693	1ST	517,15
9078920	122	T&A693	1ST	517,15
9078922	122	T&A693	1ST	517,15
9078925	122	T&A693	1ST	517,15
9078926	122	T&A693	1ST	517,15
9078928	122	T&A693	1ST	517,15
9078929	122	T&A693	1ST	517,15
9078930	122	T&A693	1ST	517,15
9078980	122	T&A699	1ST	1.901,93
9078982	122	T&A699	1ST	1.846,27
9079298	21	T&A74	1ST	10,21
9079390	28	T&A171	1ST	2.337,51
9079402	154	T&A1055	1ST	4.612,65
9079437	70	T&A370	1GN	3.538,02
9079454	70	T&A370	1GN	3.800,08
9079486	70	T&A370	1GN	3.188,58
9079523	70	T&A370	1GN	3.363,31
9079555	98	T&A756	1ST	632,81
9079575	98	T&A758	1ST	241,27
9079579	98	T&A758	1ST	272,74
9079583	98	T&A758	1ST	317,02
9079590	115	T&A973	1ST	1.296,82
9079593	34	T&A219	1ST	1.175,25
9079600	32	T&A208	1ST	12.597,58
9079603	32	T&A206	1ST	9.613,92
9079607	32	T&A204	1ST	12.597,58
9079610	32	T&A204	1ST	12.597,58
9079617	33	T&A210	1ST	12.597,58
9079618	32	T&A206	1ST	3.277,71
9079619	32	T&A206	1ST	3.277,71
9079619	33	T&A206	1ST	3.277,71
9079622	33	T&A206	1ST	3.277,71
9079622	32	T&A206	1ST	3.277,71
9079624	32	T&A204	1ST	3.277,71
9079624	33	T&A204	1ST	3.277,71
9079626	32	T&A204	1ST	3.277,71
9079626	33	T&A204	1ST	3.277,71
9079628	32	T&A204	1ST	3.277,71
9079628	33	T&A204	1ST	3.277,71
9079653	32	T&A209	1ST	1.513,42
9079653	33	T&A209	1ST	1.513,42
9079658	32	T&A209	1ST	2.502,22
9079658	33	T&A209	1ST	2.502,22
9079716	114	T&A971	1ST	7.963,61
9079719	115	T&A976	1ST	69,98
9079720	114	T&A971	1ST	7.963,61
9079731	81	T&A471	1ST	5.411,57
9079731	85	T&A471	1ST	5.411,57
9079862	113	T&A876	1ST	3.191,79
9079872	114	T&A970	1ST	9.424,45
9079874	114	T&A970	1ST	9.424,45

Bestellnummernverzeichnis

Kat-Nr.	BPL/Seite	Kat./Seite	VPE/ME	€/100*
9079878	114	T&A970	1ST	9.424,45
9079882	115	T&A972	1ST	14.332,57
9079885	115	T&A972	1ST	773,69
9079967	113	T&A905	1ST	3.855,30
9079970	113	T&A905	1ST	4.563,40
9080040	112	T&A870	1ST	20.477,93
9080084	110	T&A849	1ST	5.887,65
9080099	129	T&A1122	1ST	628,47
9080107	129	T&A1122	1ST	950,02
9080109	129	T&A1122	1ST	1.005,58
9080224	69	T&A362	1GN	2.070,10
9080225	69	T&A362	1GN	2.052,91
9080226	69	T&A362	1GN	2.070,10
9080231	69	T&A362	1GN	2.095,84
9080232	69	T&A362	1GN	2.121,60
9080233	69	T&A362	1GN	2.138,76
9080234	69	T&A362	1GN	2.155,96
9080235	69	T&A362	1GN	2.181,69
9080236	69	T&A362	1GN	2.207,44
9080237	69	T&A362	1GN	2.224,62
9080238	69	T&A362	1GN	2.241,81
9080239	69	T&A362	1GN	2.301,91
9080240	69	T&A362	1GN	2.327,65
9080241	69	T&A362	1GN	2.310,49
9080739	119	T&A684	1ST	1.508,77
9080740	119	T&A684	1ST	1.508,77
9080758	120	T&A684	1ST	943,69
9080759	120	T&A684	1ST	943,69
9080761	120	T&A688	1ST	503,77
9081331	135	T&A1340	1ST	437,89
9081657	19	T&A72	1ST	358,75
9081923	16	T&A81	1ST	543,02
9082247	113	T&A849	1ST	5.036,01
9082249	113	T&A849	1ST	5.695,74
9082378	133	T&A1090	1GN	1.348,43
9082379	132	T&A1088	1ST	859,18
9084515	153	T&A1060	1ST	1.369,12
9085654	98	T&A758	1ST	396,36
9086348	128	T&A1088	1ST	985,30
9088016	15	T&A42	1ST	593,64
9088017	15	T&A42	1ST	588,03
9088018	15	T&A46	1ST	593,64
9088019	15	T&A46	1ST	593,64
9088020	15	T&A46	1ST	588,03
9088021	16	T&A50	1ST	593,64
9088075	16	T&A50	1ST	654,52
9088249	19	T&A69	1ST	12,49
9088250	19	T&A69	1ST	12,49
9088250	89	T&A69	1ST	12,49
9088251	19	T&A70	1ST	16,06
9089587	24	T&A114	1ST	334,91
9089589	24	T&A115	1ST	301,05
9089591	24	T&A118	1ST	401,94
9089593	25	T&A119	1ST	367,21
9089597	24	T&A116	1ST	343,51
9089599	24	T&A117	1ST	308,76
9089601	24	T&A114	1ST	334,91
9089603	24	T&A115	1ST	301,05
9089605	24	T&A118	1ST	401,94
9089607	25	T&A119	1ST	367,21
9089611	24	T&A116	1ST	343,51
9089613	24	T&A117	1ST	308,76

Kat-Nr.	BPL/Seite	Kat./Seite	VPE/ME	€/100*
9089626	24	T&A114	1ST	334,91
9089628	24	T&A115	1ST	301,05
9089630	25	T&A118	1ST	401,94
9089632	25	T&A119	1ST	367,21
9089633	25	T&A121	1ST	124,25
9089636	24	T&A116	1ST	343,51
9089638	25	T&A117	1ST	308,76
9090109	16	T&A58	1ST	501,00
9090756	19	T&A71	1ST	14,35
9090864	19	T&A72	1ST	14,35
9091400	14	T&A30	1ST	333,85
9091402	14	T&A30	1ST	364,36
9091410	14	T&A30	1ST	352,63
9091412	14	T&A30	1ST	383,14
9091420	14	T&A30	1ST	371,42
9091422	14	T&A30	1ST	401,92
9091580	14	T&A30	1ST	271,26
9091590	14	T&A30	1ST	290,04
9091600	14	T&A30	1ST	308,82
9091738	12	T&A27	1ST	350,55
9091739	12	T&A27	1ST	373,09
9091740	12	T&A27	1ST	395,62
9091771	12	T&A27	1ST	377,52
9091772	12	T&A27	1ST	400,06
9091773	12	T&A27	1ST	422,57
9091803	18	T&A67	1ST	77,86
9091804	18	T&A67	1ST	77,86
9091805	18	T&A67	1ST	85,55
9091806	18	T&A67	1ST	102,85
9091820	19	T&A69	1ST	14,97
9091821	19	T&A69	1ST	14,97
9091822	19	T&A70	1ST	19,28
9094270	14	T&A34	1ST	417,31
9094280	14	T&A34	1ST	436,09
9094290	14	T&A34	1ST	454,87
9094450	14	T&A34	1ST	354,72
9094460	14	T&A34	1ST	373,50
9094470	14	T&A34	1ST	392,28
9099540	15	T&A38	1ST	568,99
9099542	15	T&A38	1ST	595,81
9099543	15	T&A38	1ST	625,46
9099550	15	T&A38	1ST	585,50
9099553	15	T&A38	1ST	641,98
9099600	15	T&A38	1ST	495,58
9099603	15	T&A38	1ST	552,03
9099610	15	T&A38	1ST	512,10
9099660	15	T&A38	1ST	513,92
9099670	15	T&A38	1ST	530,44
9099870	19	T&A70	1ST	28,70
9099871	19	T&A70	1ST	28,70
9100037	19	T&A70	1ST	34,30
9100116	19	T&A70	1ST	34,30
9101019	120	T&A693	1ST	711,08
9105927	120	T&A693	1ST	517,15
9106986	18	T&A68	1ST	132,02
9106987	18	T&A68	1ST	132,02
9106988	18	T&A68	1ST	138,41
9111484	128	T&A1088	1ST	1.014,89
9111679	45	T&A888	1ST	5.667,56
9111679	60	T&A888	1ST	5.667,56
9112981	122	T&A699	1ST	104,38
9114271	72	T&A383	1GN	2.166,20

Unverbindliche Preisempfehlung. Preise gültig bei Abnahme von ganzen Verpackungseinheiten zzgl. MwSt.

Bestellnummernverzeichnis

Kat.-Nr.	BPL/Seite	Kat./Seite	VPE/ME	€/100*
9114273	72	T&A383	1GN	2.382,81
9114274	72	T&A383	1GN	2.599,43
9114275	72	T&A383	1GN	2.816,06
9114276	72	T&A383	1GN	3.032,67
9114277	72	T&A383	1GN	3.303,44
9114548	74	T&A391	1GN	2.166,20
9114553	74	T&A391	1GN	2.382,81
9114554	74	T&A391	1GN	2.599,43
9114555	74	T&A391	1GN	2.816,06
9114557	74	T&A391	1GN	3.032,67
9115216	84	T&A455	1ST	50,78
9115217	84	T&A453	1ST	93,69
9115218	84	T&A454	1ST	94,30
9115219	84	T&A453	1ST	172,55
9116092	16	T&A80	1ST	517,02
9117200	112	T&A922	1ST	15.927,77
9117211	112	T&A922	1ST	16.012,50
9117213	112	T&A922	1ST	16.038,29
9117214	112	T&A922	1ST	16.086,18
9117223	112	T&A923	1ST	17.464,86
9117341	17	T&A64	1ST	107,34
9117491	69	T&A362	1GN	2.044,34
9121362	48	.	1ST	344,62
9121388	53	.	1ST	344,62
9121518	49	.	1ST	605,89
9121544	54	.	1ST	605,89
9122799	48	.	1ST	1.813,98
9122920	51	T&A278	1ST	2.249,69
9122922	56	T&A278	1ST	2.249,69
9122957	51	T&A282	1ST	2.646,79
9122959	56	T&A282	1ST	2.646,79
9122973	51	T&A278	1ST	1.196,08
9122975	56	T&A278	1ST	1.196,08
9122978	51	T&A282	1ST	1.794,11
9122980	56	T&A282	1ST	1.794,11
9122988	51	T&A278	1GN	1.717,06
9122988	56	T&A278	1GN	1.717,06
9122996	51	T&A282	1GN	2.252,91
9122996	56	T&A282	1GN	2.252,91
9123011	51	T&A314	1ST	104,66
9123011	56	T&A314	1ST	104,66
9123080	39	T&A258	1ST	77,75
9123080	51	T&A258	1ST	77,75
9123080	56	T&A258	1ST	77,75
9123083	48	T&A306	1ST	956,86
9123084	53	T&A306	1ST	956,86
9123086	49	T&A306	1ST	1.225,99
9123087	54	T&A306	1ST	1.225,99
9123089	50	T&A306	1ST	1.734,31
9123090	55	T&A306	1ST	1.734,31
9123524	152	T&A1023	1ST	6.889,06
9127011	50	T&A314	1ST	11,96
9127011	55	T&A314	1ST	11,96
9129712	95	T&A736	1ST	67,05
9130078	80	T&A422	1ST	224,67
9131024	135	T&A1339	1ST	224,14
9131025	135	T&A1339	1ST	295,01
9131028	135	T&A1340	1ST	150,55
9131029	135	T&A1340	1ST	221,08
9131119	106	T&A815	1GN	4.545,02
9132343	113	T&A910	1ST	11.497,91
9132399	112	T&A867	1ST	4.133,25

Kat.-Nr.	BPL/Seite	Kat./Seite	VPE/ME	€/100*
9132400	112	T&A867	1ST	4.133,25
9132546	111	T&A867	1ST	3.870,08
9132547	111	T&A867	1ST	4.643,50
9132916	116	T&A979	1ST	13.239,93
9132917	116	T&A979	1ST	13.789,23
9132918	116	T&A979	1ST	14.404,06
9132919	116	T&A979	1ST	15.166,51
9132925	116	T&A979	1ST	943,65
9133143	132	T&A1114	1ST	4.692,79
9133178	28	T&A175	1ST	815,91
9133179	28	T&A175	1ST	906,39
9133191	28	T&A175	1ST	2.126,84
9133534	16	T&A81	1ST	1.407,44
9133536	16	T&A81	1ST	1.407,44
9133906	118	T&A658	1ST	929,09
9133908	118	T&A658	1ST	929,09
9133912	118	T&A658	1ST	929,09
9133913	118	T&A658	1ST	948,51
9133916	118	T&A662	1ST	799,83
9133917	118	T&A662	1ST	799,83
9133926	119	T&A672	1ST	1.446,15
9134311	81	T&A463	1ST	10.003,74
9134400	133	T&A1092	1ST	2.005,30
9134405	133	T&A1092	1ST	2.105,57
9134678	96	T&A741	1ST	18,35
9134679	104	T&A806	1ST	8,87
9134766	133	T&A1090	1GN	2.166,11
9135140	16	T&A80	1ST	909,54
9135141	16	T&A80	1ST	1.034,00
9135703	59	T&A859	1ST	618,46
9135983	68	T&A362	1GN	2.113,03
9136065	133	T&A1098	1ST	3.288,01
9136103	81	T&A463	1ST	5.568,13
9136105	81	T&A463	1ST	2.385,90
9136121	89	T&A584	1ST	3.348,83
9136128	118	T&A658	1ST	1.397,68
9136129	118	T&A658	1ST	1.397,68
9136157	111	T&A866	1ST	32.556,18
9136158	111	T&A866	1ST	32.556,18
9136159	111	T&A866	1ST	34.095,37
9136160	111	T&A866	1ST	34.095,37
9136171	111	T&A866	1ST	36.769,52
9136172	111	T&A866	1ST	36.769,52
9136276	116	T&A977	1ST	4.378,03
9136277	116	T&A977	1ST	4.554,06
9136280	116	T&A977	1ST	4.730,02
9137114	42	T&A263	1ST	9,16
9137686	136	T&A1134	1ST	14,00
9138588	138	T&A1148	1ST	929,09
9144597	70	T&A363	1GN	136,24
9144830	70	T&A363	1ST	64,30
9144841	70	T&A363	1ST	64,30
9149261	53	T&A274	1ST	1.465,20
9149262	53	T&A274	1ST	1.475,97
9149263	53	T&A274	1ST	1.493,91
9149264	53	T&A274	1ST	1.511,83
9149265	53	T&A274	1ST	1.529,78
9149266	53	T&A274	1ST	1.547,73
9149268	53	T&A274	1ST	1.565,67
9149269	53	T&A274	1ST	1.601,54
9149270	54	T&A276	1ST	1.764,22
9149272	54	T&A276	1ST	1.774,98

Bestellnummernverzeichnis

Kat-Nr.	BPL/Seite	Kat./Seite	VPE/ME	€/100*
9149273	54	T&A276	1ST	1.792,93
9149274	54	T&A276	1ST	1.810,86
9149275	54	T&A276	1ST	1.828,80
9149276	54	T&A276	1ST	1.846,74
9149277	54	T&A276	1ST	1.864,68
9149278	54	T&A276	1ST	1.900,57
9149279	53	T&A274	1ST	388,73
9149280	54	T&A276	1ST	493,38
9149281	54	T&A278	1ST	627,94
9149282	55	T&A282	1ST	723,62
9149285	55	T&A278	1ST	655,58
9149286	55	T&A278	1ST	664,55
9149287	55	T&A278	1ST	679,49
9149288	55	T&A278	1ST	694,45
9149289	55	T&A278	1ST	709,40
9149290	55	T&A278	1ST	724,35
9149291	55	T&A278	1ST	739,30
9149292	55	T&A278	1ST	769,20
9150613	48	T&A274	1ST	1.465,20
9150614	48	T&A274	1ST	1.475,97
9150615	48	T&A274	1ST	1.493,91
9150616	48	T&A274	1ST	1.511,83
9150618	48	T&A274	1ST	1.529,78
9150619	48	T&A274	1ST	1.547,73
9150620	48	T&A274	1ST	1.565,67
9150621	48	T&A274	1ST	1.601,54
9150622	49	T&A276	1ST	1.764,22
9150623	49	T&A276	1ST	1.774,98
9150624	49	T&A276	1ST	1.792,93
9150625	49	T&A276	1ST	1.810,86
9150626	49	T&A276	1ST	1.828,80
9150627	49	T&A276	1ST	1.846,74
9150628	49	T&A276	1ST	1.864,68
9150629	49	T&A276	1ST	1.900,57
9150630	48	T&A272	1ST	388,73
9150641	48	T&A274	1ST	388,73
9150642	49	T&A276	1ST	493,38
9150643	49	T&A278	1ST	627,94
9150644	50	T&A282	1ST	723,62
9150647	50	T&A278	1ST	655,58
9150648	50	T&A278	1ST	664,55
9150649	50	T&A278	1ST	679,49
9150650	50	T&A278	1ST	694,45
9150652	50	T&A278	1ST	709,40
9150653	50	T&A278	1ST	724,35
9150654	50	T&A278	1ST	739,30
9150656	50	T&A278	1ST	769,20
9156338	83	T&A431	1ST	9.880,54
9156339	83	T&A431	1ST	7.252,56
9162402	112	T&A923	1ST	4.125,77
9180317	80	T&A422	1ST	224,67
9180318	80	T&A422	1ST	224,67
9182222	52	T&A324	1ST	200,22
9182225	52	T&A324	1ST	253,60
9182706	50	T&A306	1ST	1.047,69
9182706	52	T&A306	1ST	1.047,69
9182714	55	T&A306	1ST	1.047,69
9186461	130	T&A1094	1ST	61,09
9186461	133	T&A1094	1ST	61,09
9186462	131	T&A1101	1GN	625,60
9186463	131	T&A1101	1GN	595,75
9186464	130	T&A1100	1ST	930,40

Kat-Nr.	BPL/Seite	Kat./Seite	VPE/ME	€/100*
9186465	130	T&A1100	1ST	932,63
9192182	50	T&A314	1ST	8.348,63
9192184	55	T&A314	1ST	8.348,63
9192189	50	T&A314	1ST	7.583,12
9192191	55	T&A314	1ST	7.583,12
9192194	49	T&A314	1ST	6.147,83
9192196	54	T&A314	1ST	6.147,83
9192200	48	T&A314	1ST	5.382,35
9192202	53	T&A314	1ST	5.382,35
9192204	48	T&A306	1ST	3.468,63
9192204	49	T&A306	1ST	3.468,63
9192204	50	T&A306	1ST	3.468,63
9192206	53	T&A306	1ST	3.468,63
9192206	54	T&A306	1ST	3.468,63
9192206	55	T&A306	1ST	3.468,63
9193573	89	T&A575	1ST	3.972,39
9194922	52	T&A318	1ST	1.145,21
9194924	52	T&A318	1ST	1.321,40
9194932	44	T&A318	1ST	1.033,09
9194932	52	T&A318	1ST	1.033,09
9194933	44	T&A318	1ST	1.102,50
9194933	52	T&A318	1ST	1.102,50
9194934	44	T&A318	1ST	1.171,91
9194934	52	T&A318	1ST	1.171,91
9194935	44	T&A318	1ST	1.241,31
9194935	52	T&A318	1ST	1.241,31
9194936	44	T&A318	1ST	1.310,72
9194936	52	T&A318	1ST	1.310,72
9194937	44	T&A318	1ST	1.449,53
9194937	52	T&A318	1ST	1.449,53
9194938	44	T&A318	1ST	2.589,40
9194938	52	T&A318	1ST	2.589,40
9194939	44	T&A318	1ST	2.728,22
9194939	52	T&A318	1ST	2.728,22
9194940	44	T&A318	1ST	2.867,04
9194940	52	T&A318	1ST	2.867,04
9194966	57	T&A318	1ST	1.241,31
9194967	57	T&A318	1ST	1.310,72
9194968	57	T&A318	1ST	1.449,53
9194970	57	T&A318	1ST	2.728,22
9194997	44	T&A318	1ST	1.241,31
9194998	44	T&A318	1ST	1.310,72
9194999	44	T&A318	1ST	1.449,53
9195000	44	T&A318	1ST	2.589,40
9195001	44	T&A318	1ST	2.728,22
9195002	44	T&A318	1ST	2.867,04
9201921	83	T&A431	1ST	9.880,54
9203254	44	T&A323	1ST	337,28
9203465	44	T&A323	1ST	337,28
9203465	57	T&A323	1ST	337,28
9203466	44	T&A323	1ST	337,28
9203466	52	T&A323	1ST	337,28
9203467	44	T&A323	1ST	77,57
9203468	44	T&A323	1ST	77,57
9203468	57	T&A323	1ST	77,57
9203469	44	T&A323	1ST	77,57
9203469	52	T&A323	1ST	77,57
9203963	140	PD16	1ST	442,70
9204175	140	PD13	1ST	744,42
9204282	53	T&A330	1ST	1.130,14
9204283	53	T&A330	1ST	1.130,14
9206153	118	T&A660	1ST	616,76

Unverbindliche Preisempfehlung. Preise gültig bei Abnahme von ganzen Verpackungseinheiten zzgl. MwSt.

Bestellnummernverzeichnis

Kat.-Nr.	BPL/Seite	Kat./Seite	VPE/ME	€/100*
9206154	118	T&A660	1ST	626,24
9206675	35	T&A220	1ST	4.160,67
9206677	35	T&A220	1ST	4.160,67
9206688	35	T&A220	1ST	4.160,67
9206689	35	T&A220	1ST	4.160,67
9206690	35	T&A220	1ST	4.160,67
9206691	35	T&A220	1ST	4.160,67
9206692	35	T&A220	1ST	201,32
9206697	35	T&A220	1ST	977,86
9206830	120	T&A685	1ST	992,93
9206831	120	T&A685	1ST	992,93
9206835	120	T&A689	1ST	574,81
9207073	118	T&A660	1ST	925,15
9207074	118	T&A660	1ST	939,37
9207578	111	T&A854	1ST	12.827,41
9207642	60	T&A894	1ST	19.957,51
9208511	81	T&A463	1ST	12.080,01
9208645	106	T&A832	1ST	322,75
9208646	107	T&A832	1ST	39,51
9208647	107	T&A832	1ST	88,36
9208678	107	T&A838	1ST	93,17
9209182	120	T&A689	1ST	518,46
9209183	120	T&A688	1ST	738,47
9209218	83	T&A431	1ST	8.575,09
9209278	83	T&A432	1ST	1.789,32
9209280	83	T&A432	1ST	1.789,32
9209283	83	T&A432	1ST	1.789,32
9209578	52	T&A327	1ST	6.203,77
9209580	52	T&A327	1ST	6.377,19
9209582	52	T&A327	1ST	8.711,98
9210848	24	T&A129	1ST	34.711,26
9219328	153	T&A1039	1ST	13.716,76
9219678	152	T&A1021	1ST	18.127,88
9219966	67	T&A372	1ST	56,96
9221295	64	T&A263	1ST	56,96
9221295	67	T&A263	1ST	56,96
9221295	41	T&A263	1ST	56,96
9221295	59	T&A263	1ST	56,96
9227006	84	T&A444	1ST	1.656,78
9227245	83	T&A443	1ST	6.825,94
9227246	83	T&A443	1ST	5.363,17
9229240	84	T&A444	1ST	165,67
9229241	84	T&A444	1ST	165,67
9229243	84	T&A444	1ST	165,67
9234469	48	T&A272	1ST	1.996,25
9236526	67	T&A372	1ST	68,34
9236718	64	T&A263	1ST	628,74
9236718	67	T&A263	1ST	628,74
9236718	41	T&A263	1ST	628,74
9236718	59	T&A263	1ST	628,74
9238119	88	T&A542	1ST	7.459,00
9238120	88	T&A542	1ST	7.459,00
9238121	88	T&A542	1ST	8.017,83
9238122	88	T&A542	1ST	8.576,66
9238123	88	T&A542	1ST	8.576,66
9238124	88	T&A542	1ST	8.017,83
9239087	24	T&A107	1ST	2.073,75
9239088	24	T&A107	1ST	2.073,75
9239099	24	T&A107	1ST	2.073,75
9239288	111	.	1ST	986,77
9239310	87	T&A540	1ST	5.633,02
9239311	87	T&A540	1ST	2.933,86

Kat.-Nr.	BPL/Seite	Kat./Seite	VPE/ME	€/100*
9239784	27	T&A166	1ST	2.747,72
9240576	111	.	1ST	986,77
9240884	58	T&A302	1ST	2.047,69
9240885	58	T&A302	1ST	2.069,21
9240886	58	T&A302	1ST	2.105,10
9240887	58	T&A302	1ST	2.047,69
9240888	58	T&A302	1ST	2.069,21
9240889	58	T&A302	1ST	2.105,10
9240890	58	T&A302	1ST	2.140,97
9240891	58	T&A302	1ST	2.176,86
9240893	58	T&A302	1ST	2.212,75
9240894	58	T&A302	1ST	2.248,63
9240895	58	T&A302	1ST	2.320,38
9240897	59	T&A302	1ST	2.296,47
9240898	59	T&A302	1ST	2.332,35
9240899	59	T&A302	1ST	2.368,24
9240900	59	T&A302	1ST	2.439,98
9240920	58	T&A302	1ST	2.047,69
9240922	58	T&A302	1ST	2.069,21
9240923	58	T&A302	1ST	2.105,10
9240924	58	T&A302	1ST	2.047,69
9240925	58	T&A302	1ST	2.069,21
9240927	58	T&A302	1ST	2.105,10
9240929	58	T&A302	1ST	2.140,97
9240930	58	T&A302	1ST	2.176,86
9240931	58	T&A302	1ST	2.212,75
9240932	58	T&A302	1ST	2.248,63
9240933	58	T&A302	1ST	2.320,38
9240935	58	T&A302	1ST	2.296,47
9240936	58	T&A302	1ST	2.332,35
9240937	58	T&A302	1ST	2.368,24
9240938	58	T&A302	1ST	2.439,98
9241038	59	T&A304	1ST	1.682,08
9241049	59	T&A304	1ST	1.682,08
9241050	59	T&A304	1ST	1.682,08
9241051	59	T&A304	1ST	1.682,08
9242238	79	T&A421	1ST	4.407,06
9242240	79	T&A421	1ST	8.216,78
9242711	79	T&A421	1ST	7.136,27
9242712	79	T&A421	1ST	7.136,27
9242713	79	T&A421	1ST	9.717,08
9245377	65	.	1ST	2.129,84
9245378	65	.	1ST	2.136,12
9245379	65	.	1ST	2.140,29
9245380	65	.	1ST	2.144,47
9245381	65	.	1ST	2.150,73
9245382	65	.	1ST	2.129,84
9245383	65	.	1ST	2.136,12
9245384	65	.	1ST	2.140,29
9245385	65	.	1ST	2.144,47
9245386	65	.	1ST	2.150,73
9245387	65	.	1ST	2.157,00
9245388	65	.	1ST	2.161,18
9245389	65	.	1ST	2.269,79
9245390	65	.	1ST	2.276,06
9245391	65	.	1ST	2.386,76
9245392	65	.	1ST	2.390,94
9245393	65	.	1ST	2.499,55
9245394	66	.	1ST	2.505,81
9245395	66	.	1ST	2.512,09
9245396	66	.	1ST	2.516,26
9246312	66	.	1ST	1.989,27

Bestellnummernverzeichnis

Kat-Nr.	BPL/Seite	Kat./Seite	VPE/ME	€/100*
9246315	66	.	1ST	1.989,27
9246316	66	.	1ST	1.989,27
9247529	67	.	1ST	445,27
9247737	66	.	1ST	2.599,81
9247738	66	.	1ST	2.401,38
9247739	66	.	1ST	2.405,56
9247740	66	.	1ST	2.411,83
9247741	66	.	1ST	2.418,09
9247742	66	.	1ST	2.422,27
9247743	66	.	1ST	2.426,45
9247744	66	.	1ST	2.537,15
9247745	66	.	1ST	2.543,42
9247746	66	.	1ST	2.652,03
9247747	66	.	1ST	2.656,21
9247758	67	.	1ST	2.871,35
9247759	67	.	1ST	2.877,62
9248444	67	.	1ST	2.881,79
9248766	27	T&A166	1ST	215,40
9252651	89	T&A414	1ST	3.002,82
9253384	104	T&A794	1ST	3.479,90
9254997	153	T&A1042	1ST	16.156,26
9255240	38	T&A238	1ST	1.968,06
9255241	38	T&A238	1ST	1.992,42
9255242	38	T&A238	1ST	2.016,78
9255243	38	T&A238	1ST	2.041,15
9255244	38	T&A240	1ST	1.966,73
9255245	38	T&A240	1ST	1.981,34
9255246	38	T&A240	1ST	2.005,70
9255247	38	T&A240	1ST	2.030,06
9255248	38	T&A240	1ST	2.054,43
9255249	38	T&A240	1ST	2.078,78
9255250	38	T&A240	1ST	2.103,14
9255251	38	T&A240	1ST	2.139,89
9255252	38	T&A240	1ST	2.189,85
9255254	38	T&A242	1ST	2.388,37
9255255	38	T&A242	1ST	2.419,08
9255256	38	T&A242	1ST	2.449,79
9255257	38	T&A242	1ST	2.480,51
9255258	38	T&A242	1ST	2.511,21
9255259	38	T&A242	1ST	2.541,92
9255260	38	T&A242	1ST	2.588,26
9255262	39	T&A244	1ST	2.964,92
9255263	39	T&A244	1ST	2.988,61
9255264	39	T&A244	1ST	3.028,08
9255265	39	T&A244	1ST	3.067,56
9255266	39	T&A244	1ST	3.107,04
9255267	39	T&A244	1ST	3.146,52
9255268	39	T&A244	1ST	3.185,98
9255269	39	T&A244	1ST	3.245,54
9255270	39	T&A244	1ST	3.326,50
9255273	39	T&A246	1ST	4.306,53
9255274	39	T&A246	1ST	4.368,00
9255275	39	T&A246	1ST	4.429,46
9255276	39	T&A246	1ST	4.490,91
9255277	39	T&A246	1ST	4.552,38
9255278	39	T&A246	1ST	4.645,09
9255279	39	T&A246	1ST	4.771,14
9255280	38	T&A238	1ST	1.968,06
9255281	38	T&A238	1ST	1.992,42
9255282	38	T&A238	1ST	2.016,78
9255283	38	T&A238	1ST	2.041,15
9255284	38	T&A240	1ST	1.966,73

Kat-Nr.	BPL/Seite	Kat./Seite	VPE/ME	€/100*
9255285	38	T&A240	1ST	1.981,34
9255286	38	T&A240	1ST	2.005,70
9255287	38	T&A240	1ST	2.030,06
9255288	38	T&A240	1ST	2.054,43
9255289	38	T&A240	1ST	2.078,78
9255290	38	T&A240	1ST	2.103,14
9255291	38	T&A240	1ST	2.139,89
9255292	38	T&A240	1ST	2.189,85
9255294	38	T&A242	1ST	2.388,37
9255295	38	T&A242	1ST	2.419,08
9255296	38	T&A242	1ST	2.449,79
9255297	38	T&A242	1ST	2.480,51
9255298	38	T&A242	1ST	2.511,21
9255299	38	T&A242	1ST	2.541,92
9255300	38	T&A242	1ST	2.588,26
9255302	39	T&A244	1ST	2.964,92
9255303	39	T&A244	1ST	2.988,61
9255304	39	T&A244	1ST	3.028,08
9255305	39	T&A244	1ST	3.067,56
9255306	39	T&A244	1ST	3.107,04
9255307	39	T&A244	1ST	3.146,52
9255308	39	T&A244	1ST	3.185,98
9255309	39	T&A244	1ST	3.245,54
9255310	39	T&A244	1ST	3.326,50
9255313	39	T&A246	1ST	4.306,53
9255314	39	T&A246	1ST	4.368,00
9255315	39	T&A246	1ST	4.429,46
9255316	39	T&A246	1ST	4.490,91
9255317	39	T&A246	1ST	4.552,38
9255318	39	T&A246	1ST	4.645,09
9255319	39	T&A246	1ST	4.771,14
9255320	38	T&A238	1ST	1.968,06
9255321	38	T&A238	1ST	1.992,42
9255322	38	T&A238	1ST	2.016,78
9255323	38	T&A238	1ST	2.041,15
9255324	38	T&A240	1ST	1.966,73
9255325	38	T&A240	1ST	1.981,34
9255326	38	T&A240	1ST	2.005,70
9255327	38	T&A240	1ST	2.030,06
9255328	38	T&A240	1ST	2.054,43
9255329	38	T&A240	1ST	2.078,78
9255330	38	T&A240	1ST	2.103,14
9255331	38	T&A240	1ST	2.139,89
9255332	38	T&A240	1ST	2.189,85
9255334	38	T&A242	1ST	2.388,37
9255335	38	T&A242	1ST	2.419,08
9255336	38	T&A242	1ST	2.449,79
9255337	38	T&A242	1ST	2.480,51
9255338	38	T&A242	1ST	2.511,21
9255339	38	T&A242	1ST	2.541,92
9255340	38	T&A242	1ST	2.588,26
9255342	39	T&A244	1ST	2.964,92
9255343	39	T&A244	1ST	2.988,61
9255344	39	T&A244	1ST	3.028,08
9255345	39	T&A244	1ST	3.067,56
9255346	39	T&A244	1ST	3.107,04
9255347	39	T&A244	1ST	3.146,52
9255348	39	T&A244	1ST	3.185,98
9255349	39	T&A244	1ST	3.245,54
9255350	39	T&A244	1ST	3.326,50
9255353	39	T&A246	1ST	4.306,53
9255354	39	T&A246	1ST	4.368,00

Unverbindliche Preisempfehlung. Preise gültig bei Abnahme von ganzen Verpackungseinheiten zzgl. MwSt.

Bestellnummernverzeichnis

Kat.-Nr.	BPL/Seite	Kat./Seite	VPE/ME	€/100*
9255355	39	T&A246	1ST	4.429,46
9255356	39	T&A246	1ST	4.490,91
9255357	39	T&A246	1ST	4.552,38
9255358	39	T&A246	1ST	4.645,09
9255359	39	T&A246	1ST	4.771,14
9255764	40	T&A256	1ST	53,70
9255773	40	T&A256	1ST	53,70
9255782	40	T&A256	1ST	53,70
9255791	40	T&A256	1ST	53,70
9255800	40	T&A256	1ST	53,70
9255831	40	T&A256	1ST	174,38
9256968	41	T&A260	1ST	1.965,50
9256969	41	T&A260	1ST	1.965,50
9256971	41	T&A260	1ST	1.965,50
9256999	41	T&A260	1ST	1.965,50
9257000	41	T&A260	1ST	1.965,50
9257002	41	T&A260	1ST	1.965,50
9257004	41	T&A260	1ST	1.987,30
9257006	41	T&A260	1ST	2.008,93
9257008	41	T&A260	1ST	2.030,73
9257010	41	T&A260	1ST	2.146,83
9257034	41	T&A260	1ST	2.213,11
9257036	41	T&A260	1ST	2.233,04
9257038	41	T&A260	1ST	2.339,16
9257040	41	T&A260	1ST	2.553,49
9257041	41	T&A260	1ST	2.650,22
9257054	62	T&A354	1GN	2.054,54
9257055	62	T&A354	1GN	2.054,54
9257056	62	T&A354	1GN	2.057,36
9257057	62	T&A354	1GN	2.057,36
9257058	62	T&A354	1GN	2.057,36
9257085	62	T&A354	1GN	2.054,54
9257086	62	T&A354	1GN	2.054,54
9257087	62	T&A354	1GN	2.057,36
9257088	62	T&A354	1GN	2.057,36
9257089	62	T&A354	1GN	2.057,36
9257090	62	T&A354	1GN	2.076,13
9257091	62	T&A354	1GN	2.076,13
9257092	62	T&A354	1GN	2.094,91
9257093	62	T&A354	1GN	2.094,91
9257094	62	T&A354	1GN	2.113,69
9257095	62	T&A354	1GN	2.113,69
9257096	62	T&A354	1GN	2.226,35
9257097	63	T&A354	1GN	2.226,35
9257121	63	T&A354	1GN	2.470,46
9257123	63	T&A354	1GN	2.489,23
9257124	63	T&A354	1GN	2.601,90
9257125	63	T&A354	1GN	2.601,90
9257126	63	T&A354	1GN	2.714,56
9257127	63	T&A354	1GN	2.827,23
9257128	63	T&A354	1GN	2.939,90
9257129	63	T&A354	1GN	3.165,22
9257130	63	T&A354	1GN	3.390,55
9257268	63	T&A355	1GN	440,90
9257269	40	T&A252	1ST	4.975,50
9257270	40	T&A252	1ST	5.952,00
9257271	40	T&A252	1ST	7.440,00
9257273	40	T&A252	1ST	4.975,50
9257274	40	T&A252	1ST	5.952,00
9257275	40	T&A252	1ST	7.440,00
9257277	40	T&A252	1ST	4.975,50
9257278	40	T&A252	1ST	5.952,00

Kat.-Nr.	BPL/Seite	Kat./Seite	VPE/ME	€/100*
9257279	40	T&A252	1ST	7.440,00
9257319	153	T&A1070	1ST	6.227,64
9257320	153	T&A1038	1ST	14.880,76
9257321	154	T&A1042	1ST	4.781,00
9257323	153	T&A1040	1ST	2.487,11
9257324	153	T&A1040	1ST	2.487,11
9257326	154	T&A1059	1ST	6.936,98
9257327	152	T&A1032	1ST	893,81
9257611	40	T&A252	1ST	220,44
9257612	40	T&A252	1ST	291,92
9257613	40	T&A252	1ST	426,35
9257615	40	T&A252	1ST	220,44
9257616	40	T&A252	1ST	291,92
9257617	40	T&A252	1ST	426,35
9257619	40	T&A252	1ST	220,44
9257620	40	T&A252	1ST	291,92
9257621	40	T&A252	1ST	426,35
9257643	40	T&A257	1ST	5.027,03
9257645	40	T&A257	1ST	8.294,60
9257647	40	T&A257	1ST	7.148,44
9257649	40	T&A257	1ST	11.114,76
9257651	40	T&A254	1ST	1.722,33
9257652	40	T&A254	1ST	1.722,33
9257653	40	T&A254	1ST	1.722,33
9257663	40	T&A254	1ST	2.546,21
9257664	40	T&A254	1ST	2.546,21
9257665	40	T&A254	1ST	2.546,21
9257702	39	T&A240	1ST	46,50
9257703	41	T&A257	1ST	17,41
9257704	41	T&A257	1ST	17,41
9257705	41	T&A257	1ST	17,41
9257706	63	T&A341	1ST	232,75
9257725	70	T&A400	1ST	814,98
9257727	70	T&A400	1ST	814,98
9257734	40	T&A253	1ST	488,25
9257735	40	T&A253	1ST	488,25
9257736	40	T&A253	1ST	488,25
9257813	154	T&A1059	1ST	7.420,38
9257890	64	T&A262	1ST	1.928,00
9257890	41	T&A262	1ST	1.928,00
9257891	64	T&A262	1ST	1.928,00
9257891	41	T&A262	1ST	1.928,00
9257892	64	T&A262	1ST	1.928,00
9257892	41	T&A262	1ST	1.928,00
9257893	64	T&A262	1ST	1.928,00
9257893	41	T&A262	1ST	1.928,00
9262213	42	T&A263	1ST	280,94
9264191	88	T&A541	1ST	1.673,70
9265958	88	T&A541	1ST	8.941,30
9265959	88	T&A541	1ST	8.941,30
9265960	88	T&A541	1ST	8.382,47
9266111	88	T&A541	1ST	7.823,63
9266112	88	T&A541	1ST	8.382,47
9266113	88	T&A541	1ST	7.823,63
9266220	88	T&A541	1ST	1.826,95
9268681	41	T&A260	1ST	2.172,54
9268684	63	T&A354	1GN	2.451,68
9275785	78	T&A413	1ST	21.557,55
9275786	78	T&A413	1ST	21.150,36
9275794	78	T&A413	1ST	15.727,53
9275796	78	T&A413	1ST	15.320,34
9276643	78	T&A413	1ST	14.175,00

Bestellnummernverzeichnis

Kat-Nr.	BPL/Seite	Kat./Seite	VPE/ME	€/100*
9276645	78	T&A413	1ST	14.175,00
9276732	78	T&A413	1ST	7.050,00
9276735	78	T&A413	1ST	7.050,00
9277096	79	T&A421	1ST	4.407,06
9277098	79	T&A421	1ST	8.216,78
9277155	79	T&A422	1ST	207,80
9277156	79	T&A422	1ST	376,68
9277164	79	T&A421	1ST	7.601,73
9277167	79	T&A421	1ST	12.811,89
9277440	79	T&A422	1ST	543,48
9277610	110	T&A848	1ST	11.770,43
9277621	110	T&A848	1ST	11.941,95
9277630	110	T&A849	1ST	5.313,61
9277856	124	T&A718	1ST	1.612,01
9277857	124	T&A718	1ST	746,90
9277858	124	T&A718	1ST	854,37
9277859	124	T&A718	1ST	209,56
9277885	134	T&A1268	1ST	44.941,99
9277886	134	T&A1268	1ST	44.941,99
9277887	134	T&A1268	1ST	44.941,99
9277991	87	T&A538	1ST	2.898,42
9278004	87	T&A538	1ST	2.898,42
9278260	87	T&A538	1ST	2.898,42
9278285	87	T&A538	1ST	2.898,42
9278316	44	T&A322	1ST	4.209,04
9278319	44	T&A322	1ST	4.209,04
9278332	44	T&A322	1ST	4.209,04
9278336	45	T&A884	1ST	16.176,53
9278337	45	T&A884	1ST	16.823,61
9278452	64	T&A263	1ST	148,89
9278452	42	T&A263	1ST	148,89
9278453	42	T&A263	1ST	3.304,00
9278485	87	T&A538	1ST	3.290,70
9278486	87	T&A538	1ST	3.290,70
9278571	87	T&A538	1ST	3.290,70
9278580	87	T&A538	1ST	3.290,70
9278657	78	T&A413	1ST	22.304,36
9278672	78	T&A413	1ST	12.825,00
9278694	87	T&A539	1ST	2.558,41
9278742	87	T&A539	1ST	3.837,51
9278780	78	T&A413	1ST	31.360,74
9278791	78	T&A413	1ST	32.194,25
9278798	78	T&A413	1ST	20.100,00
9278799	78	T&A413	1ST	20.100,00
9278801	78	T&A414	1ST	1.800,00
9279390	45	T&A885	1ST	1.027,48
9279390	59	T&A885	1ST	1.027,48
9279391	45	T&A885	1ST	1.109,67
9279391	59	T&A885	1ST	1.109,67
9279392	45	T&A885	1ST	1.150,77
9279392	59	T&A885	1ST	1.150,77
9279393	45	T&A885	1ST	3.082,41
9279393	59	T&A885	1ST	3.082,41
9279394	45	T&A885	1ST	6.404,02
9279394	59	T&A885	1ST	6.404,02
9279396	45	T&A885	1ST	1.109,67
9279396	60	T&A885	1ST	1.109,67
9279397	45	T&A885	1ST	1.571,07
9279397	60	T&A885	1ST	1.571,07
9279398	45	T&A885	1ST	1.282,28
9279398	60	T&A885	1ST	1.282,28
9279399	45	T&A885	1ST	2.942,56

Kat-Nr.	BPL/Seite	Kat./Seite	VPE/ME	€/100*
9279399	60	T&A885	1ST	2.942,56
9279404	59	T&A886	1ST	19.041,90

Unverbindliche Preisempfehlung. Preise gültig bei Abnahme von ganzen Verpackungseinheiten zzgl. MwSt.

IMPRESSUM

Ausgabe 2021/2022

Herausgeber
Einkaufsbüro Deutscher
Eisenhändler GmbH
EDE Platz 1
42389 Wuppertal

Gesamtleitung

(Verantwortlich i. S. d. PresseR):
E/D/E Leitung Lieferanten-/Warengruppen-
und Vertriebskonzeptmanagement Bau,
Michael Hatke

im März 2021

BEDINGUNGEN

1. Diese Publikation hat eine Laufzeit vom 01.03.2021 bis zum 31.07.2022. Nach dem Ablaufdatum verlieren insbesondere auch alle genannten Preise ihre Gültigkeit, gleiches gilt bei Erscheinen eines Nachfolgekataloges.
2. Diese Publikation dient ausschließlich der gewerblichen Verwendung.
3. Alle genannten Preise sind freibleibend und verstehen sich jeweils zuzüglich der gesetzlichen Mehrwertsteuer. Wir müssen uns bei Veränderungen am Markt vorbehalten, die am Tage der Lieferung gültigen Preise zu berechnen.
4. Sofern nicht anders angegeben, gilt der in der Publikation genannte Preis jeweils für ein Warenstück. Sofern Verpackungseinheiten (VE) angegeben sind, kann die Ware nur in kompletten VE abgegeben werden. Bei größeren Abnahmemengen ist im Zweifel ein spezielles Angebot anzufordern.
5. Diese Publikation ist urheberrechtlich geschützt. Jegliche Art der Vervielfältigung, auch auszugsweise, ist nur mit ausdrücklicher Genehmigung des Urhebers gestattet.
6. In der Publikation verwandte Bilder können von der Originalware abweichen. Für evtl. Druckfehler, Produktänderungen durch technische Weiterentwicklungen und Modellwechsel kann keine Haftung übernommen werden. Ebenso können aus drucktechnischen Gründen die Farben in der Publikation vom Originalfarbton der Produkte abweichen.
7. Im Übrigen liegen allen Auftragsabwicklungen und Lieferungen unsere Verkaufs-/Lieferungs- und Zahlungsbedingungen zugrunde.

Scharniere	11 – 29
Klappenbeschläge	31 – 35
Schubkastensysteme	37 – 60
Auszugsführungen für Holzschubkästen	61 – 75
Schiebe- und Falttürsysteme	77 – 90
Verbindungstechnik	92 – 107
Schrankinnenausstattung	109 – 116
Möbelschließsysteme	117 – 125
Büromöbelsysteme	127 – 138
ProDecor Griffe	139 – 150
Verarbeitungshilfen	151 – 155
Bestellnummernverzeichnis	156 – 169

BAU- UND MÖBELBESCHLÄGE

LAGERSORTIMENT HETTICH

» 2021



» KEIN ANBRUCH- UND MINDERMENGENZUSCHLAG
» KEINE KOSTEN BEI ABWEICHENDER LIEFERANSCHRIFT

» 24-STUNDEN-LIEFERSERVICE
» GÜLTIG VOM 01.03.21 BIS 31.07.22

**EINKAUFSBÜRO
DEUTSCHER
EISENHÄNDLER GMBH**

HAUSADRESSE:
E/D/E PLATZ 1
42389 WUPPERTAL

POSTADRESSE
42387 WUPPERTAL

www.ede.de